

Digital Microscope Cameras for Materials Science:
Clear Images, Precise Analysis



Passionate about Imaging: Olympus Digital Cameras

Versatility, performance, precise color reproduction, and integration into Olympus imaging platforms are characteristics that all Olympus microscope cameras share. Today, digital cameras are an indispensable tool in microscopy systems. The need to reliably acquire clear, crisp images is vital to every microscopist. No one understands this better than Olympus with its long and successful history in microscopy and lens design. Utilizing our long history integrating optical and digital technologies, Olympus developed a comprehensive range of digital cameras that are optimized for applications in materials science.

Advanced Image Sensors

The image sensor is the heart of any digital camera. This electronic component is responsible for digitizing images by acquiring, storing, and converting electron signals within an array. Sensors have a variety of resolutions measured by the number of pixels in their array. The number of pixels in the image sensor, the pixel size, and the mechanisms that convert light into electrons vary by camera type. Different combinations of these factors result in subtle changes in brightness and define the ultimate resolution of the digital image.

Appropriate Sensor Types

Olympus utilizes only highly efficient CCD and CMOS sensors. CCD sensors are the most common type used in Olympus microscope cameras. For research applications, the sensor of choice is the CCD or high-performance CMOS. The cost-effective CMOS sensor used in our SC50 camera is energy efficient and optimized for brightfield microscopy. Often used for general inspection purposes, these scientific-grade sensors are designed so that all pixels are devoted to capturing light and providing near dark uniformity for maximum flexibility in advanced materials science applications.

Pixel Shift Technology

Capturing nine times the detail of stationary sensor cameras, pixel shift technology is ideal for optimizing the resolution on your microscope, an essential feature for low power microscopes. In addition, a new 3CMOS pixel shift mode in the DP74 camera enables three-color image resolution (RGB) within a single pixel to further improve resolution.

Fast and Efficient

Sensor signal processing is crucial to delivering reliable performance in a diverse range of industrial applications. Olympus cameras can detect up to 14 bits per channel, enabling fast and efficient image analysis. High frame rates facilitate real-time image viewing to focus and navigate to areas of interest directly on the PC screen.

Color Fidelity

Precise color reproduction and recording is important and a major challenge in image processing and documentation. Olympus cameras incorporate sophisticated algorithms that precisely distinguish color intensities, helping achieve maximum dynamic range and color fidelity.

Sensitivity

Cameras with sensitive sensors are normally used in difficult imaging conditions and for image analysis applications. The sensitivity of Olympus cameras can be increased by using various binning modes.

Resolution

The SC180 camera is an ideal choice for applications requiring display, measurement, and analysis. The camera's exceptional resolution allows it to document the fine structures and details, down to $1.25\ \mu\text{m} \times 1.25\ \mu\text{m}$. With a pixel count of up to 18 million (18 megapixels), the SC180 exploits the full optical resolution of the objectives, making it possible to capture and document tiny details at very low magnifications.

4K Microscopy

Olympus 4K Microscopy cameras combine advanced digital capabilities with increased resolution and field of view for fast, highly-detailed sample analysis. Live imaging and fast focusing contribute to faster inspections, and observations can be confirmed on-screen with only occasional use of the instrument's oculars.

Software Control

The advanced integration of all Olympus cameras in OLYMPUS Stream image analysis software provides intuitive operation from basic or advanced image acquisition to image processing, report generation, data export, and globally sharing of images and reports.

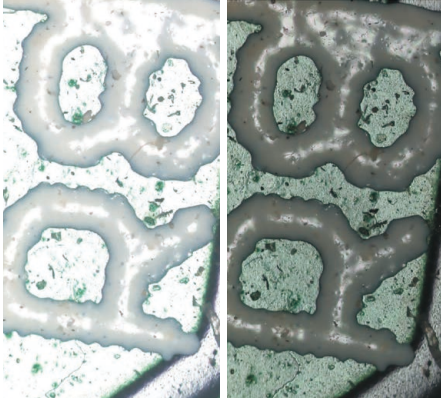

Improved image quality—
Left: without HDR; right: with HDR

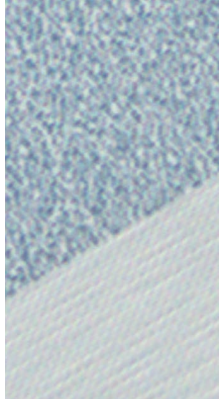

Improved resolution—
Left: standard camera; right: high-resolution camera



Improved color reproduction—
Left: without color correction; right: with color correction

Instant MIA: Easily move the stage for panoramic images

With instant multiple image alignment (MIA), you can now stitch images easily and quickly just by moving the XY knobs on the manual stage; no motorized stage is necessary. OLYMPUS Stream software uses pattern recognition to generate a panoramic image, giving users a wider field of view than a single frame.



Instant MIA image of a coin

EFI: Create all-in-focus images

The extended focus imaging (EFI) function within OLYMPUS Stream software captures images of samples whose height extends beyond the depth of focus of the objective and stacks them together to create one image that is all in focus. EFI can be executed with either a manual or motorized Z-axis and creates a height map to easily visualize the sample's structure. It is also possible to construct an EFI image using offline using Stream Desktop software.

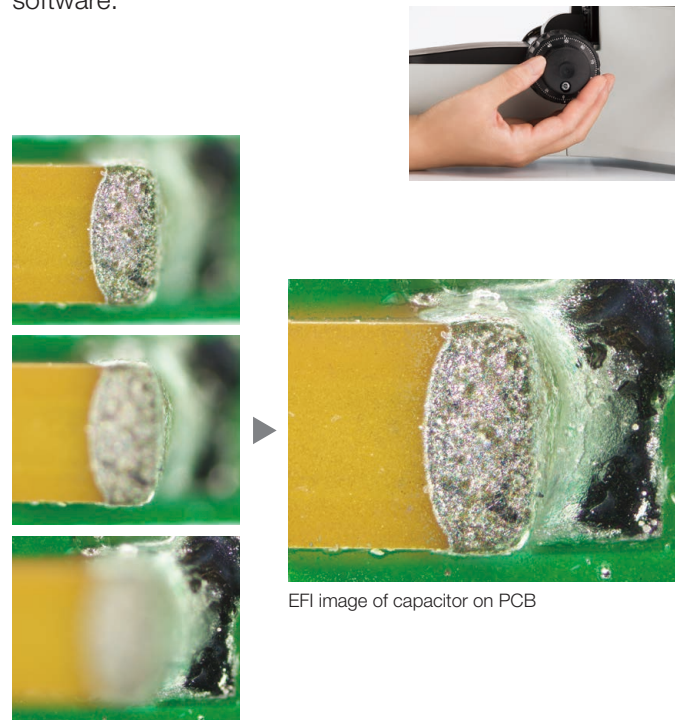

EFI image of capacitor on PCB

Digital Microscope Cameras for a Range of Applications

Meeting the challenges of modern microscopy requires a diverse range of sensors. Olympus offers a sophisticated portfolio of digital color cameras that cover an array of materials science applications. The sensor lineup ranges from cameras for documentation purposes to cooled, high-performance, high-sensitivity cameras for advanced applications. All cameras are optimized to provide high-performance digital imaging with Olympus microscopes and image analysis software systems.

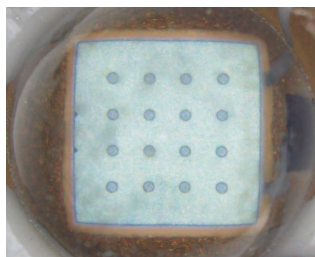

With standard mode

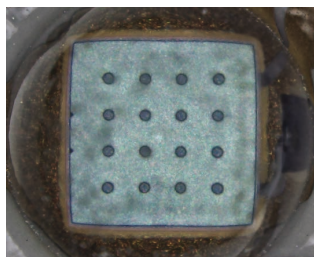

Crisp images with LiveHDR mode (DP74)

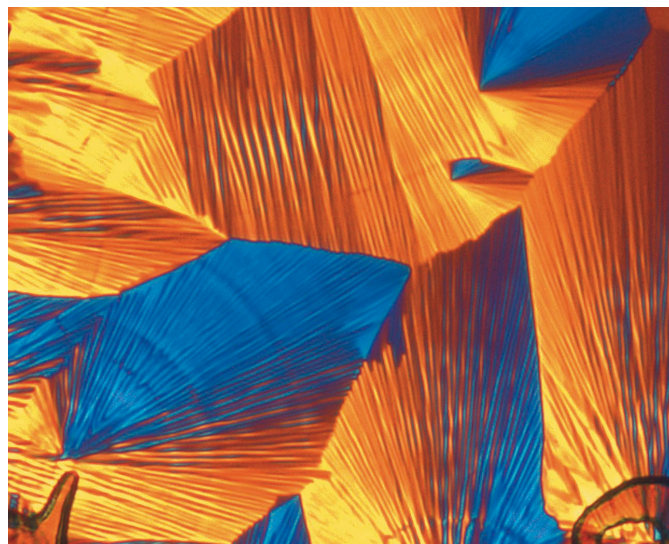

Preeminent performance — Polarized image

Universal Camera Models

Universal cameras combine: high resolution, high sensitivity, and high-speed data transfer in any illumination mode. This makes them suitable for many applications including inspection, quality control, and materials science research, e.g. image analysis or digital brightfield documentation. These cameras are easy to use and feature real-time image viewing, true color fidelity, and special modes for image acquisition in difficult lighting conditions — including the unique LiveHDR mode (DP74), an application that optimizes contrast and brightness in individual image regions.

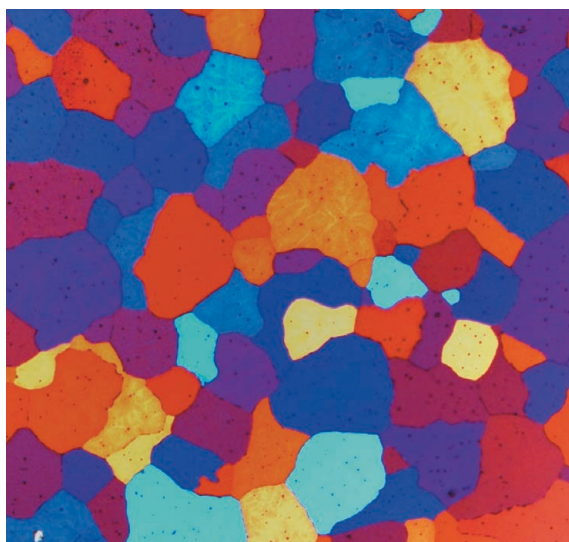

Etched aluminum acquired with the DP27

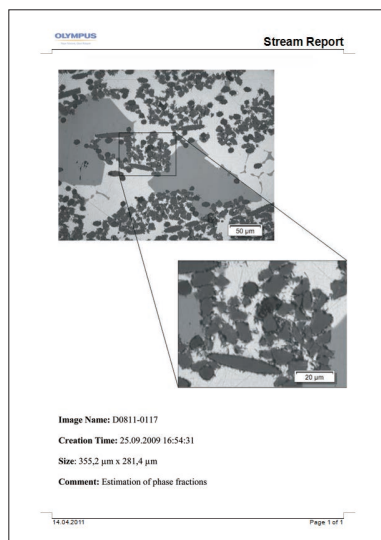

Suitable for digital documentation

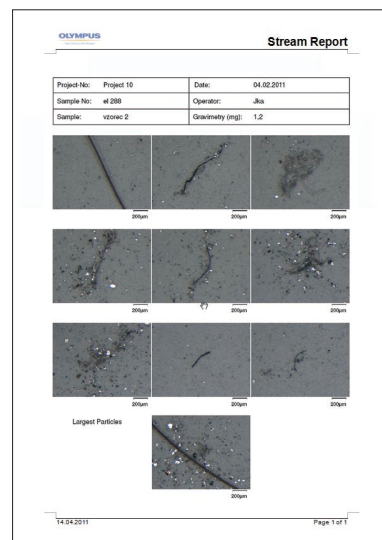

Standard Camera Models

Olympus standard camera models offer balanced solutions for general documentation and image processing. Equipped with 5-megapixel and greater CCD, cameras capture images at a high resolution—enabling large fields of view to be captured at low magnification and providing vivid clarity so that images remain clear even when digitally enlarged. Olympus cameras are also suitable for use in visual inspection and image processing thanks to true color capabilities, providing faithful color reproduction for a variety of samples.

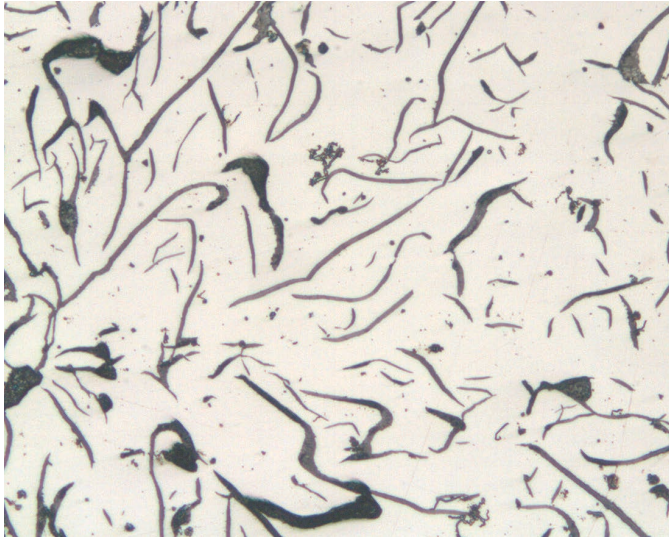

Brightfield acquisition for standard applications

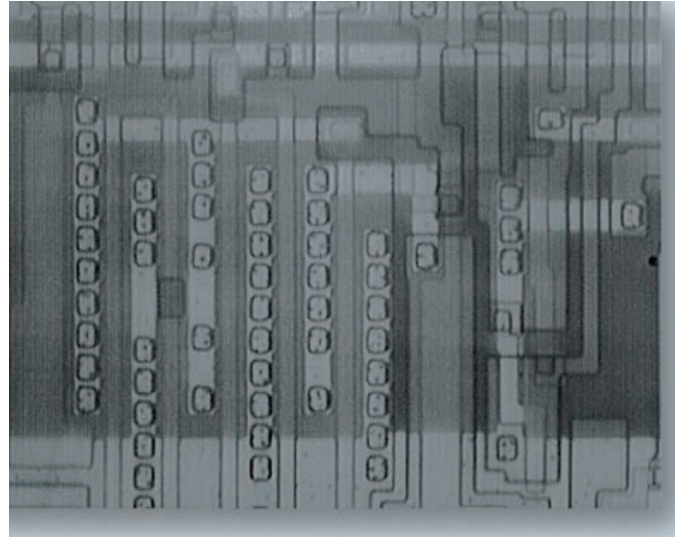

Infrared image acquired with the XM10-IR camera

Introductory Camera Models

The specifications of sensors used in cost-effective camera models make them the practical choice for standard brightfield applications and highly suitable for simple digital documentation purposes. With their low cost and outstanding performance, these are excellent entry-level cameras for digital image acquisition in microscopes.

Gray Scale Camera Models

Olympus offers gray scale cameras to provide a suitable solution for difficult imaging conditions such as fluorescence observation and near-IR imaging. The XM10-IR is a highly sensitive monochrome camera that features a cooled 1.4-megapixel CCD. The camera provides a spectral sensitivity from the visible to 1050 nm and is ideal for thin, through-silicon near-IR imaging. With a 14-bit analog-to-digital converter (ADC), these cameras are used when gray scale values are of utmost importance.

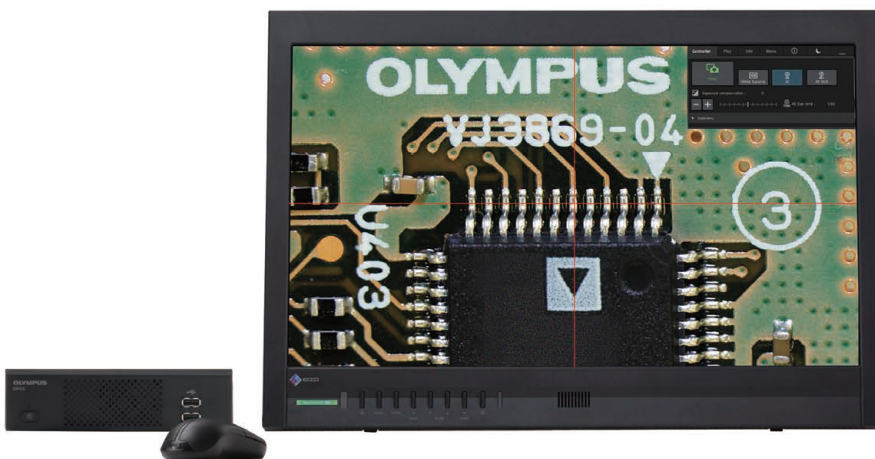

Stand-alone camera — DP22/DP27 configuration example

Stand-Alone Camera Models

The DP22 and DP27 cameras can be used as advanced stand-alone models (no PC required). These cameras are ideal when precious bench space is limited. Both cameras can be controlled from a dedicated control box, providing smooth and intuitive operation via a touch-screen monitor or a mouse.

Advanced Digital Microscope Cameras for Demanding Applications

Olympus offers a wide range of digital cameras for acquiring high-quality images that feature high resolution and contrast and true-to-life color reproduction. Some cameras, such as the XM10IR monochrome camera, are optimized for dedicated applications such as providing dependable gray scale value and infrared images. Other cameras, like the DP74, offer flexibility to deal with different applications, materials, sizes, or shapes. OLYMPUS Stream software provides intuitive control for whatever camera you choose.

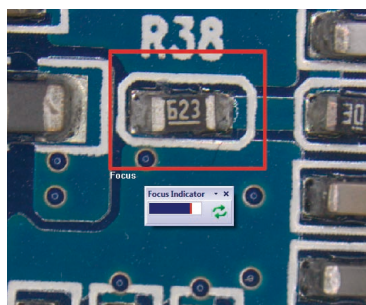

Live Inspection and Movie Recording

Even though camera speed is important when dealing with inspection tasks and online recording, image quality is also important. The most suitable choice is a camera that offers a high frame rate at full resolution, such as the SC180 with 4K ultra-high-definition (UHD). For live inspection without the need for UHD, the DP22 is a suitable camera for a stand-alone set up.

Olympus Recommends

- DP22
- DP74
- UC90*
- SC50
- SC180

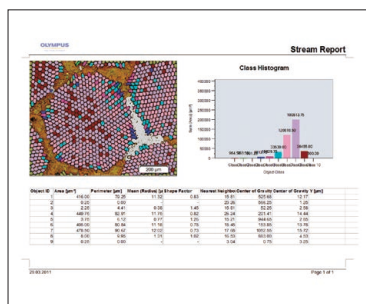

Documentation

Documentation is a well established task in industry and materials science. A camera mainly used for reporting should have a minimum of 3 megapixels and accurate color reproduction. When you need detail zooming in your reports, a camera with more than 5 megapixels is recommended for more appropriate results.

Olympus Recommends

- DP27
- DP74
- SC50
- SC180

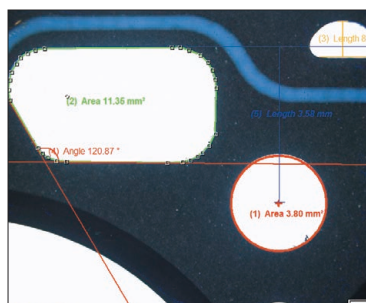

Measurements

Interactive measurements are standard tasks in materials science. For straightforward measurements 3-megapixel cameras are sufficient.

Olympus Recommends

- DP27
- DP74
- UC90*
- UC50

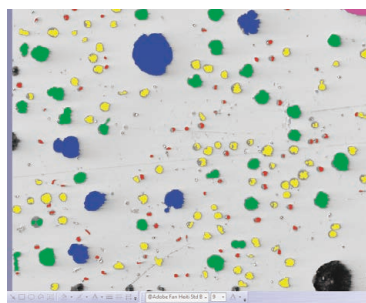
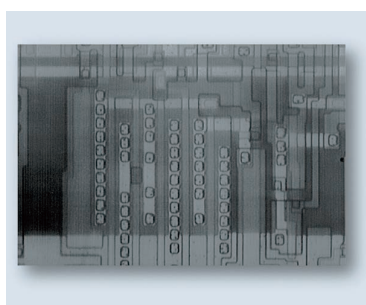

Image Analysis

Color reproduction is the main concern when you need to classify objects in color. Sensitivity is the other concern when dealing with image processing. Sensitivity can be increased by cooling and binning. Cooled models offer the advantage of images shown at full resolution while image resolution is reduced using binning.

Olympus Recommends

- DP74
- UC90*
- SC50
- SC180



Difficult Imaging Conditions

Imaging under low light conditions, like fluorescence, requires a very sensitive sensor. A monochrome sensor is most suitable choice for this application. For infrared image acquisition, a monochrome sensor can be equipped with a special filter to provide a spectral response that is ideal for thin, through-silicon, near-IR imaging.

Olympus Recommends

- DP74
- XM10
- XM10IR

* UC90 is not available for Asian countries.

OLYMPUS Stream Software Adapts to Your Needs for an Efficient Workflow

The OLYMPUS Stream image analysis software enables users to seamlessly acquire, process, and measure images, and create a flexible database. OLYMPUS Stream software provides the flexibility to fit your applications and meet your needs without changing your operation. Time is just as important as working conditions, and the OLYMPUS Stream system can be personalized to fit your process flow. An easy-to-use interface guides the user from image adjustment and capture to measuring, reporting, and archiving. As a result, you'll be able to achieve your tasks more efficiently, regardless of their complexity.



OLYMPUS Stream software's user interface for image acquisition (DP74)

Full Integration

All Olympus digital cameras integrate and work with OLYMPUS Stream software. The camera control tool window groups all necessary functions in an efficient overview: observe, adjust, and snap.

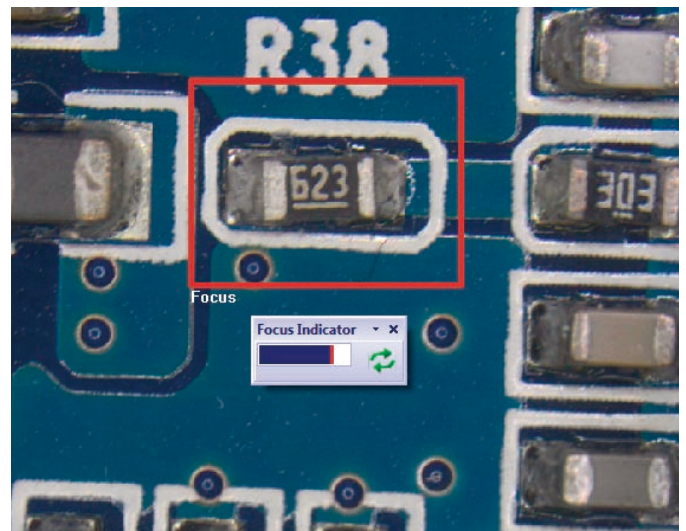

Focused live image

Live Zoom and Focus

The OLYMPUS Stream focus indicator enables the user to select a region of interest and bring it into optimum focus using the microscope's focus control.

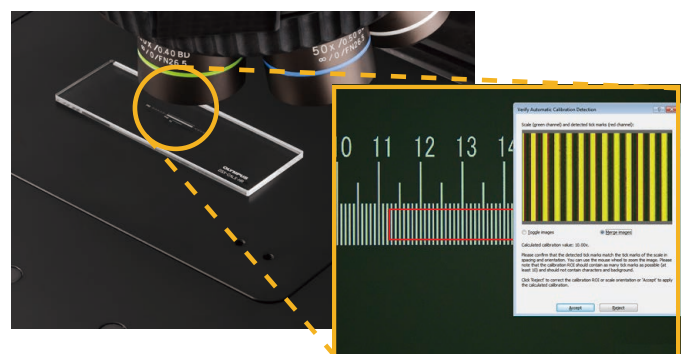

Auto Calibration

Similar to digital microscopes, automatic calibration is available when using OLYMPUS Stream software. Auto calibration helps eliminate human variability in the calibration process, leading to more reliable measurements. Auto calibration uses an algorithm that automatically calculates the correct calibration from an average of multiple measurement points. This minimizes variance introduced by different operators and maintains consistent accuracy, improving reliability for regular verification.

Microscope Digital Camera Specifications

| Specifications | Universal model | | Standard model | | |
|--------------------------------|--|---------------------------------------|-------------------------|----------------------------|---------------------------|
| | Outstanding performance | Best addressable resolution in series | Versatile | Exceptional color fidelity | Well-balanced performance |
| Digital camera | DP74 | SC180 | UC90⁵ | DP27 | SC50 |
| Resolution (megapixels) | 20.7 | 18.0 | 9.0 | 5.0 | 5.0 |
| Chip size (inches) | 1/1.2 in. Color CMOS | 1/2.3 in. Color CMOS | 1 in. Color CCD | 2/3 in. Color CCD | 1/2 in. Color CMOS |
| Pixel size (µm) | 5.86 × 5.86 | 1.25 × 1.25 | 3.69 × 3.69 | 3.45 × 3.45 | 2.2 × 2.2 |
| Exposure times | 39 µs–60 s | 22 µs–1 s | 100 µs–10 s | 50 µs–8 s | 31 µs–2.74 s |
| ADC ^{*2} | 12-bit | 12-bit | 14-bit | 12-bit | 12-bit |
| Live frame rates ^{*4} | 60 | 59 to 10.5 | 61 to 19.5 | 30 to 15 | 77 to 15 |
| Dimensions (mm, Ø × H) | 116 (Ø) × 87.7 (H) | 58 (Ø) × 32 (H) | 86 (Ø) × 47 (H) | 77 (Ø) × 42.5 (H) | 58 (Ø) × 33 (H) |
| Weight (g, approx) | 1100 | 188 | 530 | 160 | 182 |
| 3CMOS mode | Available | — | — | — | — |
| LiveHDR | Available | — | — | — | — |
| Camera adapter | C-mount | | | | |
| Control box | — | — | — | DP2-SAL | — |
| PC interface | PCI Express × 4 Rev.2.0 or later Compatible with low profiles | USB 3.0 | USB 3.0 | USB 3.0 | USB 3.0 |

| Specifications | Introductory model | Stand-alone model ^{*1} | B/W model | |
|-------------------------|-----------------------|---------------------------------|---------------------------|---------------------------|
| | Cost-effective models | Space-saving | Monochrome imaging | For IR observation |
| Digital camera | LC30 | DP22 | XM10 | XM10IR |
| Resolution (megapixels) | 3.1 | 2.8 | 1.4 | 1.4 |
| Chip size (inches) | 1/2 in. Color CMOS | 1/1.8 in. Color CCD | 2/3 in. Monochrome CCD | 2/3 in. Monochrome CCD |
| Pixel size (µm) | 3.2 × 3.2 | 3.69 × 3.69 | 6.45 × 6.45 | 6.45 × 6.45 |
| Exposure times | 57 µs–750 ms | 50 µs–8 s | 100 µs–160 s | 100 µs–160 s |
| ADC ^{*2} | 10-bit | 12-bit | 14-bit | 14-bit |
| Live frame rates | 49 to 10 | 30 to 25 | 80 to 15 | 80 to 15 |
| Dimensions (mm, Ø × H) | — ^{*3} | 77 (Ø) × 42.5 (H) | 86 (Ø) × 48 (H) | 86 (Ø) × 48 (H) |
| Weight (g, approx) | 41 | 160 | 420 | 420 |
| 3CMOS mode | — | — | — | — |
| LiveHDR | — | — | — | — |
| Camera adapter | C-mount | | | |
| Control box | — | DP2-SAL | — | — |
| PC interface | USB 2.0 | IUSB 3.0 | IEEE 1394a | IEEE 1394a |

^{*1} The DP27 may also be used a stand-alone model. ^{*2} Analog-to-digital converter. The camera's actual bit depth depends on the software used.

^{*3} The LC30 is not cylindrical unlike other cameras. Dimensions (H × W × D): 48.6 × 44 × 31

^{*4} Frame rate depends on the condition of your PC and/or software.

^{*5} UC90 is not available for Asian countries.

PC Requirements

| | |
|-----------------------|--|
| CPU | Intel Core i5, Intel Core i7, Intel Xeon, (or equivalent) |
| RAM ^{*1} | 4 GB or more (8 GB recommended) |
| Hard disk | 2.4 GB or more free space |
| Graphic ^{*2} | VGA card of PCI Express X16 available for 32-bit color with 1280 × 1024 or more* The onboard graphic is also usable. |
| OS ^{*3} | Microsoft Windows 10 Pro (64-bit), Microsoft Windows 8.1 Pro (64-bit), Microsoft Windows 7 Ultimate/Professional SP1 (32-bit/64-bit) Language: English/Japanese |

^{*1} Required dual-channel for DP74.

^{*2} Required configurations for LiveHDR in DP74.

• Graphic board applicable to CUDA made by NVIDIA (compute capability 2.1 or more)

• Graphic board driver applicable to CUDA 7.0 or more

^{*3} Required 64-bit for LiveHDR, Pixel shift, and 3-CMOS functions in DP74.

• OLYMPUS CORPORATION is ISO14001 certified.

• OLYMPUS CORPORATION is ISO9001 certified.

• All company and product names are registered trademarks and/or trademarks of their respective owners.

• Images on the PC monitors are simulated.

• Specifications and appearances are subject to change without any notice or obligation on the part of the manufacturer.

www.olympus-ims.com

OLYMPUS[®]

OLYMPUS CORPORATION

Shinjuku Monolith, 2-3-1 Nishi-Shinjuku, Shinjuku-ku, Tokyo 163-0914, Japan

N8600594-032018