

Scanners and Accessories



- Manual Scanners
- Motorized Scanners
- Accessories

The Company

Olympus Corporation is renowned for its pioneering work in optical technology, electronics, and precision manufacturing. A leader in providing solutions for customers in the industrial and life science markets, Olympus Scientific Solutions, a business of Olympus Corporation, offers a comprehensive portfolio of advanced technologies including remote visual, microscopy, ultrasound, eddy current, eddy current array, and X-ray fluorescence.

Our commitment to designing quality products is directly linked to our customers' responsibility to help ensure safety, quality, and reliability by complying with the highest industry standards and regulations to help people lead safe and productive lives.

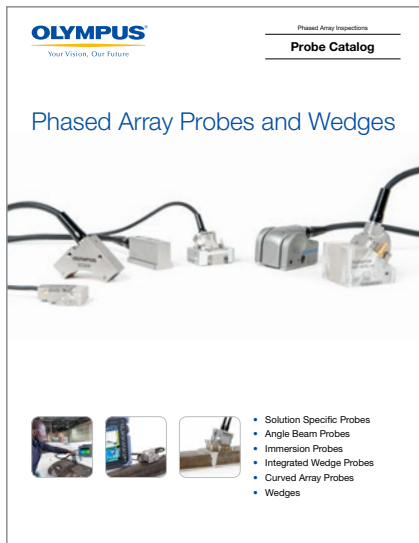

Scanners are usually not supplied with probes and wedges. For phased array probes and wedges, refer to the Phased Array Probes and Wedges catalog; for UT probes and wedges, refer to the Ultrasonic Transducers catalog.

Table of Contents

Scanners

Scanner Technical Matrix	4
Scanner Application Matrix	4
Scanner Encoder Connector Compatibility	4
Manual One-Axis Scanners	5
VersaMOUSE™ – Manual One-Line Indexer Scanner	5
Mini-Wheel™ – Small Footprint Encoder	6
HST-X04 – TOFD Weld Inspection	6
HST-Lite Scanner for TOFD Weld Inspection	7
COBRA® Scanner for Weld Inspection of Small-Diameter Pipes	8
HSMT-Compact™ Scanner for Weld Inspection	10
HSMT-Flex™ Scanner for Weld Inspection	11
RollerFORM® Phased Array Wheel Probe	12
HydroFORM®/RexoFORM™ Scanner for Corrosion Mapping	14
FlexoFORM™ Scanner for Pipe Elbow Inspection	16
Motorized One-Axis Scanner	18
WeldROVER™ Scanner for Weld Inspection	18
Motorized Two-Axis Scanner	20
MapROVER™ Scanner for Corrosion Mapping	20
SteerROVER™ Scanner for Weld Inspection and Corrosion Mapping	22
Manual Two-Axis Scanner	24
ChainSCANNER™ Solution for Pipe Inspection	24
MapSCANNER™ Solution for Corrosion Mapping	26
GLIDER™ Scanner for Composite Inspection	27

Accessories

Pulsers and Preamplifiers	28
TRPP 5810™ Pulser/Preamplifier for TOFD Inspection	28
5682 Preamplifier for TOFD Inspection	29
PR-06-04 Pulser/Preamplifier for Pulse-Echo Inspection	29
Cables and Adaptors	30
Umbilical Cables	30
Adaptors and Extension Cables	31
Interbox	32
Indexer Clicker	32
Couplant Feed Units	33
CFU03 and CFU05 Electric Couplant Feed Units	33
Manual Couplant Feed Units	33
Yokes	34
Aqualene Elastomer Couplant	34

Scanners and Accessories

The capacity to accurately position probes according to the surface being inspected greatly influences inspection quality. Depending on the application, constraints can arise that make probe positioning difficult. Olympus offers a wide range of industrial scanners and accessories to assist inspectors in their work while providing optimal data acquisition. Some of the applications covered by our scanner product line are weld inspection, corrosion mapping, and aerospace. Supported technologies include phased array, conventional ultrasonic, time-of-flight diffraction (TOFD), eddy current, and eddy current array. Scanner configurations include one- or two-encoded axes and manual or motorized options.

Scanner Technical Matrix

Inspection Technology	One-Axis Scanner		X-Y Scanner	
	Manual	Motorized	Manual	Motorized
Conventional Ultrasonics	HSMT-Compact™ HSMT-Flex™ HST-X04™	WeldROVER™	ChainSCANNER™ GLIDER™	MapROVER™ SteerROVER™
TOFD	HST-X04 HST-Lite HSMT-Compact HSMT-Flex	WeldROVER	ChainSCANNER	SteerROVER
Phased Array	Mini-Wheel™ VersaMOUSE™ RollerFORM FlexoFORM HydroFORM®/RexoFORM™ COBRA® HSMT-Compact HSMT-Flex	WeldROVER	Mini-Wheel + Indexer-Clicker VersaMOUSE RollerFORM® ChainSCANNER MapSCANNER™ GLIDER FlexoFORM	MapROVER SteerROVER
Phased Array and TOFD	HSMT-Compact HSMT-Flex	WeldROVER	ChainSCANNER	SteerROVER

Scanner Application Matrix

Scanner Model		Mini-Wheel	VersaMOUSE	COBRA	HST-X04	HST-Lite	HSMT-Compact	HSMT-Flex	WeldROVER	ChainSCANNER	MapROVER	SteerROVER	HydroFORM	RexoFORM	FlexoFORM	MapSCANNER	GLIDER	RollerFORM
Application	Weld	✓	✓	✓	✓	✓	✓	✓	✓	✓	✓	✓						
	Corrosion	✓	✓							✓	✓	✓	✓	✓	✓	✓	✓	
	Aerospace	✓	✓														✓	✓

Scanner Encoder Connector Compatibility

Except when stated otherwise, scanners sold after July 2013 come standard with a LEMO® connector that is compatible with current generation OmniScan® and FOCUS instruments. For use on a different instrument, an optional adaptor is required.

Required Encoder Cable Adaptor

Instrument	Scanner Connector	
	LEMO (From 07/2013)	DE15 (Prior to 07/2013)
OmniScan MX1	Omni-A-ADP27 [U8780329]	N.A.
TomoScan FOCUS LT	C1-LF-BXM-0.3M [U8769010]	C1-DE15F-BXM-0.30M [U8767107]
Current OmniScan and FOCUS Instruments	N.A.	Omni-A2-ADP20 [U8775201]

Manual One-Axis Scanners

VersaMOUSE™ – Manual One-Line Indexer Scanner

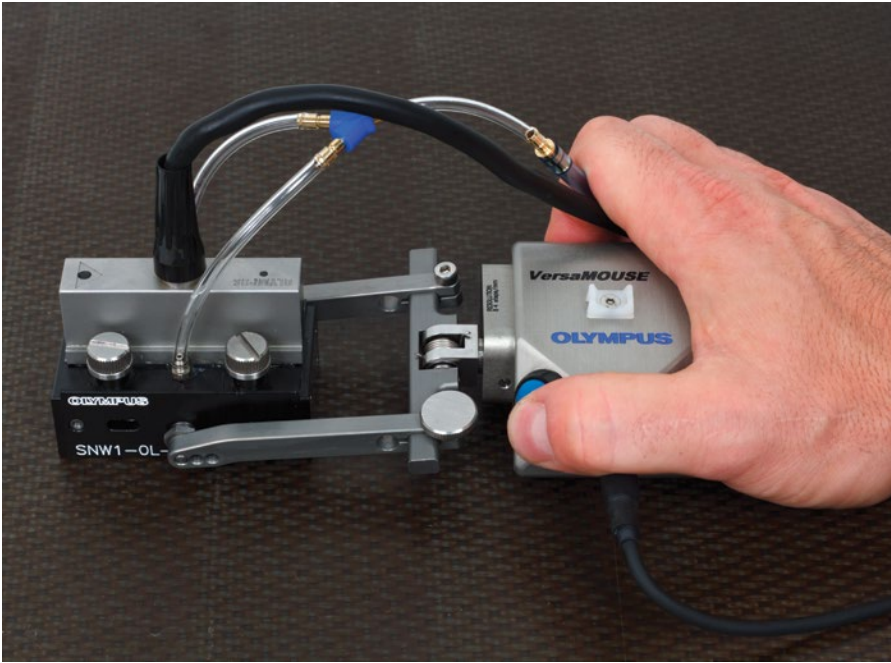

The VersaMOUSE™ scanner is designed for linear encoded scans with a phased array probe. The integrated indexing button makes it ideal for 2D mapping applications such as CFRP flat panel and corrosion inspections. The VersaMOUSE scanner can perform an encoded one-line scan followed by indexing the position in the perpendicular direction. Another one-line scan can then be performed and juxtaposed to the previous scan. This process is repeated to produce a complete 2D map of the area of interest.

The scanner's adjustable yoke is easy to set up on an IHC-type wedge using standard attachment holes. The spring-loaded system is optimized to offer the lowest clearance possible. The yoke is attached to the scanner using a quick-connect system, which keeps the probe either parallel or at a 90° skew to the scan axis.

The encoder's wheels are designed to resist slippage on wet surfaces. The rugged construction makes this scanner an affordable, reliable solution for all phased array inspections performed with a single probe. For even better stability on ferromagnetic surfaces, an optional magnetic wheel package is available.

Specifications

Probe Holder Position	Length in Scan Axis (mm)	Width (mm)	Height (mm)	Weight (kg)
Front	170	80	42	0.4
Side	80	152	42	0.4

Features

- Encoded linear scan (one axis) for phased array inspection.
- Integrated clicker button for indexing enabling 2-D mapping.
- Adjustable fork for easy and fast installation of multiple wedge dimensions.
- Two rubber wheels that remain in contact with the surface for maximum adherence.
- An easily clipped and spring-loaded yoke that can be positioned with a 90° skew.
- Encoder resolution: 8.4 steps/mm.
- Durable aluminum body and waterproof construction.

Standard Inclusions

- 2.5 m encoder cable.
- One adjustable PA yoke (width: 65 mm, length: 65 mm).
- Carrying case.

Note: Probes and wedges are not included with the scanner.

Options

Magnetic Wheels package

Optional magnetic wheels provide maximum adherence and improved stability on ferromagnetic surfaces.

P/N: Versa -A-MagWheel [U8775247]



VersaMOUSE and RexoFORM scanners for corrosion inspection.



An easily clipped and spring-loaded yoke that can be positioned with a 90° skew.

Mini-Wheel™ – Small Footprint Encoder



The Mini-Wheel™ encoder is used for the positioning and dimensioning of defects in the scan axis and can synchronize data acquisition with probe movement. Typical applications are laboratory testing, training, and manual inspection data sampling*.

The Mini-Wheel encoder is waterproof and compatible with the HST-X04 scanner. Mount standard Olympus wedges using the included bracket kit. This miniature encoder is made entirely of stainless steel and features sealed bearings for long-lasting smooth operation. The custom electronic circuit was designed to prevent noise induction in UT signals.

Ordering Information

Part Number	Item Number	Connector	Compatibility
ENC1-2.5-LM	U8775295	LEMO	Current OmniScan® instruments
ENC1-2.5-DE	U8780197	DE-15	OmniScan MX
ENC1-2.5-BX	U8780196	Bendix	TomoScan Focus LT

The cable length suggested in the table is 2.5 m. Other lengths are available.

HST-X04 – TOFD Weld Inspection

Part Number	Item Number	Description
HST-X04	U8750007	Package includes: Mini-Wheel™ encoder 2x 10 MHz, 3 mm TOFD probes 2x 5 MHz, 6 mm TOFD probes 2x ST1-45L-IHC 2x ST1-60L-IHC 2x ST1-70L-IHC 2x 5 m LEMO® 00 to Microdot™ UT cables 2x LEMO 00 to BNC adaptors
HST-X04-SCN	U8779098	Scanner and Mini-Wheel encoder only (no probes, wedges, or cables)
HST-X04-PA	U8775137	Scanner holds 40 mm wide phased array wedges and a Mini-Wheel encoder (no probes, wedges, or cables).

Features

- Waterproof (IP68).
- Stainless steel construction.
- Encoder resolution of 12 steps/mm.
- Removable encoder wheel.
- Overmold rubber wheel for better grip.
- Sealed bearing for long-lasting smooth wheel rotation.
- Spring-loaded attachment system.
- Threaded holes for alternative mounting.

Standard Inclusions

- One encoder with standard rubber wheel.
- One mounting bracket kit and tools.

Options

Magnetic Wheel

Use the optional magnetic wheels for maximum adherence to ferromagnetic surfaces. The first P/N is compatible with the O-ring tire encoder and the V2 is for the overmold tire encoder.

P/N: ENC1-A-MagWheel [U8902964]
ENC1-A-MagWheel-V2 [U8775290]

Mounting Bracket Kit

The extra mounting bracket kit is used to mount the Mini-Wheel encoder on a wedge.

P/N: ENC1-BRACK [U8775120]

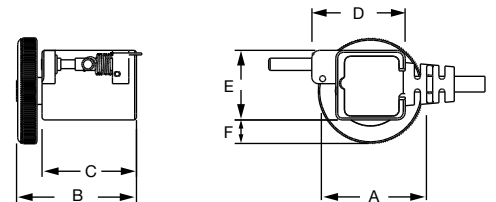

A = 27 mm

B = 31 mm

C = 24.5 mm

D = 24.2 mm

E = 18 mm

F = 6.1 mm

*For high-rate inspection, use of a scanner with heavy-duty encoding devices is recommended.



The HST-X04™ TOFD manual scanner offers an efficient, low-cost weld inspection solution.

HST-Lite Scanner for TOFD Weld Inspection

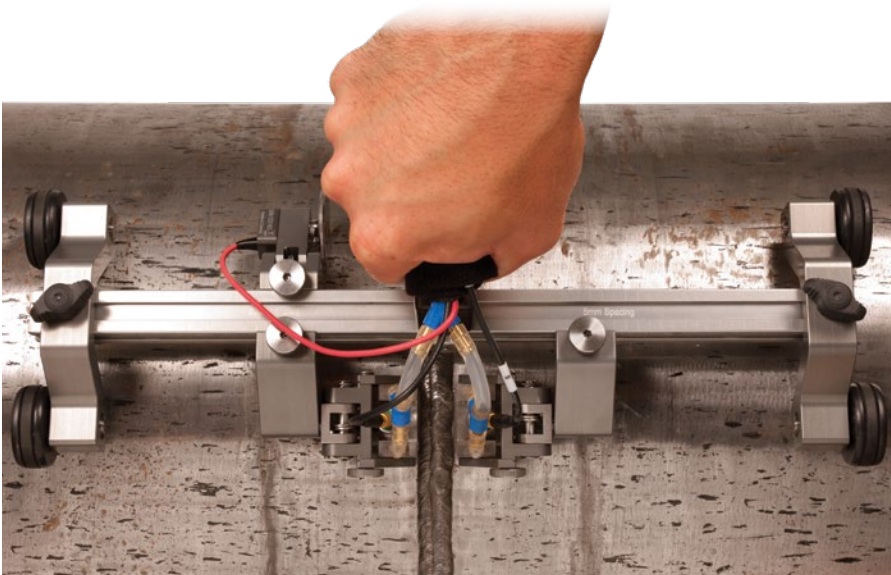

The new HST-Lite scanner is the perfect choice for cost-effective, one-channel TOFD inspections when signal quality is important. The combination of magnetic wheels and spring-loaded probe holders offer the stability required to perform high-quality, one-line inspections. The scanner can be operated using only one hand and will attach to ferromagnetic surfaces even when in an upside-down position.

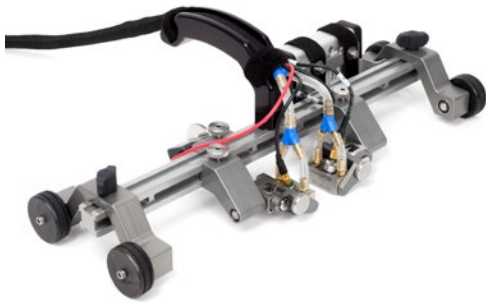

The scanner's position can be encoded on flat surfaces or around the circumference of pipes as small as 4.5 in. (114.3 mm) OD. Adjustment of the scanner components can be performed without tools.

Ordering Information

Part Number	Item Number	Description
HST-Lite	U8750061	Scanner (see standard inclusions).
HST-Lite-kit01	U8750062	Package includes: Scanner 2x 10 MHz, 3 mm TOFD probes 2x 5 MHz, 6 mm TOFD probes 2x ST1-45L-IHS 2x ST1-60L-IHS 2x ST1-70L-IHS 2x 5 m LEMO® 00 to Microdot™ UT cables 2x LEMO 00 to BNC adaptors

Features

- Circumferential scans performed with two TOFD probes on pipes 4.5 in. (114.3 mm) OD or greater.
- Four magnetic wheels firmly attach the unit to ferromagnetic inspection surfaces.
- Light aluminum frame.
- Independently positioned and spring-loaded probe holders.
- Waterproof, spring-loaded encoder with 9 step/mm resolution.
- Removable handle for lower profile.
- Attachment devices for umbilical cables.
- The frame design enables probes to be positioned outside the wheels (2 additional magnetic wheels are required).
- Engraved references on the scanner and pointer on the probe holders ensure easy probe separation measurement.

Standard Inclusions

- Scanner frame with handle.
- Four magnetic wheels.
- Waterproof, spring-loaded wheel encoder with 5 m cable.
- Two spring-loaded arms (SLA) with TOFD-P/E yokes (31.75 mm wide with 5 mm diameter buttons).
- Irrigation tubing and accessories.
- Cable conduit.
- Carrying case.

Note: Probes and wedges are not included with the scanner.

Specifications

Length in Scan Axis (mm)	Width (mm)	Height (mm)	Weight (kg)
125	385	100*	1,3

*67 mm without handle

Options

Couplant-Feed Units

See the accessories section on page 33.

5682 Remote Pre-amplifier Kit

P/N: 5682-KIT02 [U8779091]

Magnetic Wheels

P/N: CHAINSCAN-A-MWHEEL [U8779383]

Replacement Encoder

P/N: HST-Lite-SP-ENC [U8775277]

Extra Handle

P/N: HST-Lite-A-Handle [U8775278]

Extra TOFD Probe Holder Kit

P/N: HST-Lite-A-PH-TOFD [U8775279]

COBRA® Scanner for Weld Inspection of Small-Diameter Pipes

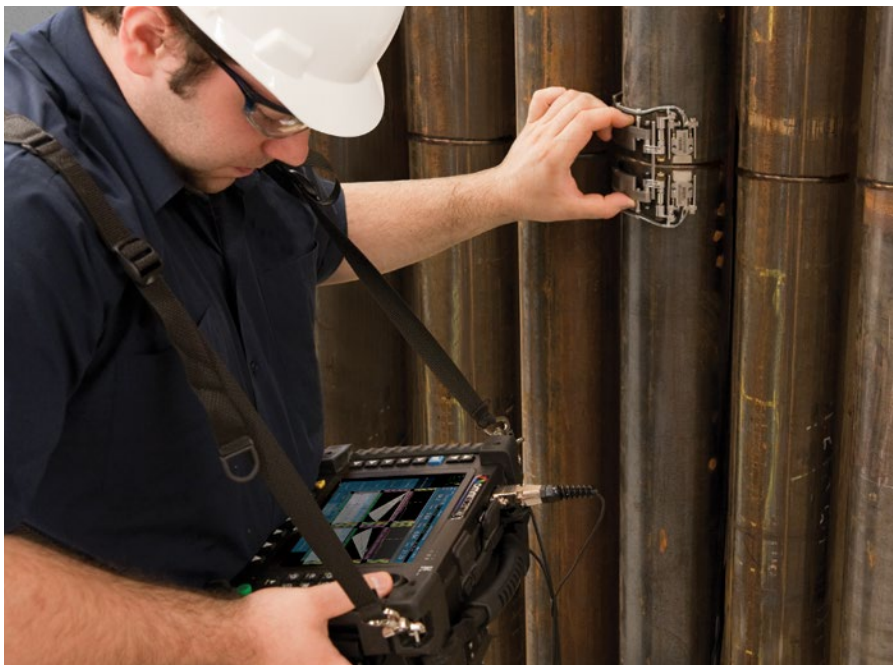

The COBRA® manual scanner, combined with an OmniScan® phased array flaw detector, is used to perform circumferential weld inspections on small-diameter pipes. The COBRA scanner holds up to two PA probes for inspections on pipes with outside diameters ranging from 0.84 in. (21 mm) to 4.5 in. (114 mm).

With its very slim design, this manual scanner inspects pipes in limited access areas where minimal clearance is required. Adjacent obstructions, such as piping, supports, and structures, can be as close as 12 mm (0.5 in.). This spring-loaded scanner is designed to clasp carbon steel and stainless steel pipes of various diameters using multiple links. This unique feature enables the scanner to be installed and operated from one side of a row of pipes. The COBRA scanner is characterized by its smooth-rolling encoded movement, which enables accurate data acquisition. The scanner holds up to two phased array probes for complete inspection of the weld in one pass. For pipe-to-component inspections, the scanner can be configured quickly to perform one-sided inspections using a single probe.

This Olympus solution uses low-profile phased array probes with optimized elevation focusing, enhancing detection of small defects in thin-wall pipes. Specially designed low-profile wedges fitting each pipe diameter covered by the scanner are available for a complete solution.

The COBRA scanner ensures stable, constant, and strong pressure, thus providing good UT signals and precise encoding around the full circumference of the pipe.

Features

- Covers standard pipes from 0.84 in. to 4.5 in. OD (21 mm to 114 mm).
- Operates within 12 mm (0.5 in.) clearance (on all standard pipes), permitting inspections in limited access areas.
- Holds up to two phased array probes for complete weld coverage in one pass.
- Easy installation and manipulation from one side of a row of pipes.
- Can be configured to perform one-sided inspections for pipe-to-component evaluations.
- The included mechanical setup templates eliminate the need for pipe samples when preparing the scanner for standard pipes.
- The design provides stable and constant pressure around the full circumference of the pipe.
- Urethane wheels provide smooth radial movement and limited axial drift.
- Encoder resolution of 32 steps/mm.
- Compact, lightweight, and portable.
- Wedges and probes can be changed quickly and easily.
- The distance between probes can be adjusted from 0 mm to 55 mm.
- The spring-loaded scanner can be used on ferromagnetic and nonferromagnetic pipes.
- Waterproof and rust free.



The COBRA scanner on a 0.84 in. pipe with two A15 PA probes with an OmniScan® MX2 16:64 flaw detector displaying two PA groups with sectorial scans and C-scans.

Probes

Part Number	Item Number	Freq. (MHz)	Number of Elements	Pitch (mm)	Elevation (mm)	Elevation Curvature Radius (mm)
2.25CCEV35-A15C-P-2.5-OM*	U8331117	2.5	16	0.5	10	35
3.5CCEV35-A15C-P-2.5-OM*	U8331149	3.5	16	0.5	10	35
5CCEV35-A15-P-2.5-OM	U8331163	5.0	16	0.5	10	35
7.5CCEV35-A15-P-2.5-OM	U8330826	7.5	16	0.5	10	35
10CCEV35-A15-P-2.5-OM	U8331014	10.0	32	0.3	7	35

These probes come standard with an OmniScan® connector and a 2.5 m (8.2 ft) cable.

* A15C casing are based on the same design as the A15 but are 2 mm taller, increasing height clearance.

Wedges

Specially designed SA15 low-profile wedges are available with the different axial outside diameters (AOD) specified in the table below. These wedges have been optimized to position the A15 probe as close as possible to the weld to reduce the number of skips required and as low as possible for maximum height clearance. This is accomplished with no acoustic compromises. These wedges are fitted with irrigation ports and holes for scanner mounting and can be configured to generate 60° shear (N60S) or longitudinal (N60L) waves in steel. Wedges for TOFD inspection are also available (use 3 mm diameter element ST1 probes) with the following refracted angles in steel: 60L, 70L, and 80L.

Note: height clearance required for longitudinal wave inspection is 25 mm with the SA15 and SA25 and 35 mm with the ST1 and right angle cable connector.

Standard Wedge AOD Values and Pipe OD

AOD (in.)	Minimum OD (in.)	Maximum OD (in.)
0.84	0.800	0.840
1.05	0.840	1.050
1.315	1.050	1.315
1.66	1.315	1.660
1.9	1.660	1.900
2.375	1.900	2.375
2.875	2.375	2.875
3.5	2.875	3.500
4.0	3.500	4.000
4.5	4.000	4.500



The solution uses low-profile phased array probes with optimized elevation focusing, which improves the detection of small defects in thin-wall pipes.



Wedges for TOFD inspection are also available.



The A25 dual linear array probe (DLA) series is designed to inspect austenitic material that cannot be otherwise inspected using an A15 probe in pulse echo.

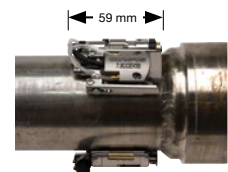

The COBRA® scanner can also be configured for pipe-to-component weld inspections.

Ordering Information

Part Number	Item number	Description	Package PN: COBRA-K-4.5 (U8750055)
COBRA	U8750053	Small pipe scanner kit with encoder for coverage of 0.84 in. to 4.5 in. OD standard pipes; packaged in hard carrying case	✓
7.5CCEV35-A15-P-2.5-OM	U8330826	Low-profile phased array probe (16 elements, 7.5 MHz)	✓ (x2)
COBRA-A-SA15	U8721205	2 flat SW wedges, plus 10 pairs of curved SW wedges for pipes of 0.84 in. to 4.5 in. OD	✓
COBRA-A-SA15LW	U8722168	2 flat LW wedges, plus 10 pairs of curved LW wedges for pipes of 0.84 in. to 4.5 in. OD	
COBRA-A-ST1-70L	U8701348	2 flat wedges, plus 9 pairs of curved TOFD wedges for pipes of 1.05 in. to 4.5 in. OD	
COBRA-SP-BASIC	U8775166	Basic spare parts kit	
COBRA-SP-FULL	U8775188	Basic spare parts kit plus links and the encoder assembly	
COBRA-SP-SA15	U8750056	One of each of the 11 wedges needed for coverage of 0.84 in. to 4.5 in. OD pipes	
OMNI-A2-SPLIT128	U8100133	Y-adaptor (splitter) to support 2 phased array probes on OmniScan MX2 instruments with PA2 128 elements module	
OMNI-A2-SPLIT64	U8100135	Y-adaptor (splitter) to support 2 phased array probes on OmniScan MX2 instruments with PA2 64 elements module	
OMNI-A-ADP05	U8767016	Y-adaptor (splitter) to support 2 phased array probes on OmniScan MX instruments	
E128P0-0000-OM	U8800428	Phased array cable extensions required to interface between the Omni-A-ADP05 and an OmniScan MX2 instrument with PA1 128 elements module	
EIB64-NT-0-P-0-OM	U8779452	Interbox to support 2 phased array probes on OmniScan MX2 instruments with PA1 64 elements module	
WTR-SPRAYER-4L	U8775153	4 L manual water pump with irrigation tubes and fittings	

HSMT-Compact™ Scanner for Weld Inspection



The HSMT-Compact™ manual one-axis encoded scanner is designed for maintenance weld inspection. It is small, light, and versatile and can be used with up to four probes on plates as well as for circumferential scans on pipes as small as 4.5 in. (114.3 mm) OD. The scanner width can be adjusted and the frame can be extended outside the limit of the wheels to provide a configuration that is suitable for hard-to-reach places, such as pipe-to-component welds.

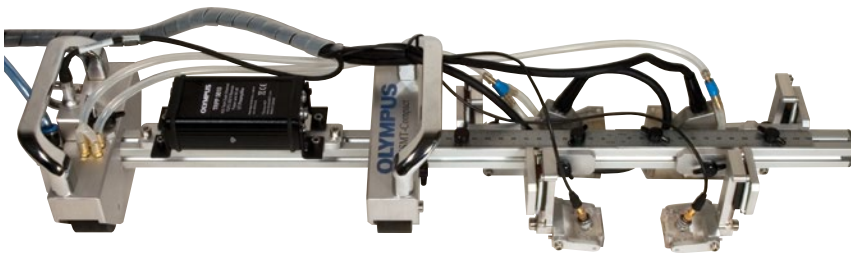

This configuration is suitable for hard-to-reach places, such as pipe-to-component welds.

Options

Divisible Cable Conduit

See the accessories section on page 30.

Couplant-Feed Units

See the accessories section on page 33.

Remote Pulser/Preamplifier

See the accessories section on page 28.

Extra Probe Holder Kit

Set of two short, spring-loaded arms (SLA) mounted on 90° brackets.

P/N: OPTX0739 [U8779086]

Yokes

See the accessories section on page 34.

Replacement Encoder

P/N: ACIX895 [U8775097]

Spare Parts Kit

P/N: OPTX689 [U8775021]

Features

- Enables circumferential scan using up to four probes (UT or PA) on 4.5 in. (114.3 mm) OD pipes, or greater.
- Four plastic-covered magnetic wheels hold the unit against a ferromagnetic inspection surface.
- Light aluminum frame with customizable width.
- The frame design enables probes to be positioned outside the wheels.
- Independently positioned and spring-loaded probe holders.
- Waterproof, spring-loaded encoder with a 12 steps/mm resolution.
- Removable handles for lower profile.
- Attachment devices for umbilical cables.
- An integrated water manifold that simplifies couplant distribution.
- Metric/US Customary unit rulers on the scanner for easy probe separation measurement.

Standard Inclusions

- Scanner frame with handles, and:
 - 250 mm (10 in.) frame bar
 - 450 mm (18 in.) frame bar
 - 650 mm (26 in.) frame bar
- Four plastic-covered magnetic wheels.
- Waterproof, spring-loaded wheel encoder with a 5 m cable.
- Four 90° probe holder brackets.
- Four spring-loaded arms (SLA).
- Four TOFD-P/E 31.75 mm yokes.
- Two PA 40 mm x 38 mm yokes.
- Two 55 mm yoke arm pairs
- Irrigation tubing and accessories.
- Cable conduit attachment fixture.
- Carrying case.

Note: the umbilical cable, probes, and wedges are not included with the scanner.

Specifications

Length in Scan Axis (mm)	Width (mm)	Height (mm)	Weight (kg)
152	94 + bar length	102	3.2

HSMT-Flex™ Scanner for Weld Inspection

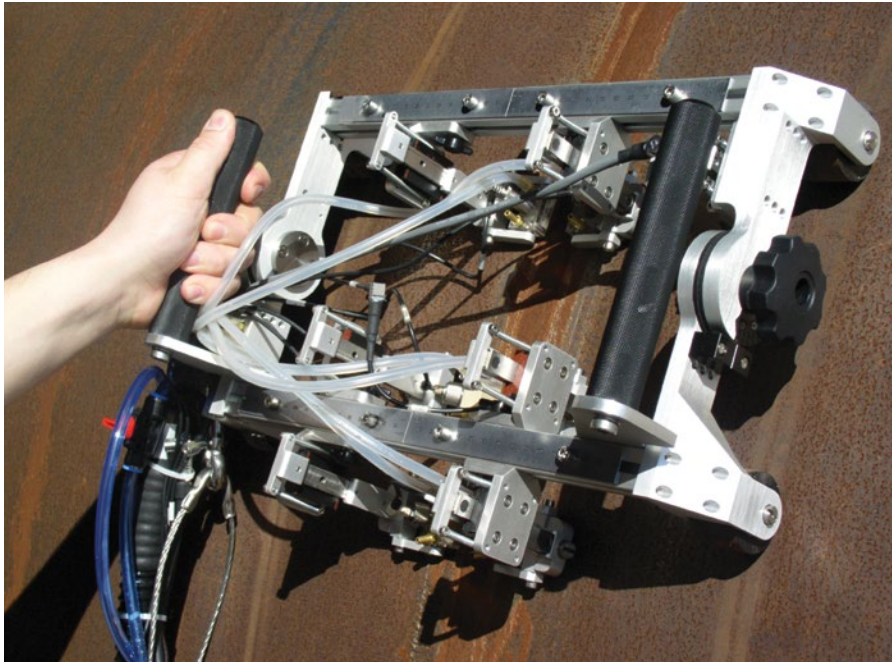

The HSMT-Flex™ scanner is intended for one-axis encoded inspection of circumference welds on pipes of 4.5 in. (114.3 mm) OD and greater. The scanner comes equipped with four probe holders, but can be mounted with a total of eight probes with optional probe holders. Mounted probes can be either phased array or conventional UT to provide the most efficient inspection results.

The major characteristic of the scanner is its ability to bend in the center. This feature enables the scanner to fit on smaller pipes and also brings the force of the spring-loaded arm in the radial direction of the pipes for better stability of the wedge and optimum data acquisition. Optional pivoting probe holders can also be installed on the outside of the scanner.

Options

Umbilical

See the accessories section on page 30.

Remote Pulsar/Preamplifier

See the accessories section on page 28.

Couplant-Feed Units

See the accessories section on page 33.

Laser Guide Kit

Battery-operated laser guiding device for easier weld tracking.

P/N: HSMT-A-Laser [U8779087]

Yokes

See the accessories section on page 34.

Replacement Encoder

P/N: ADIX1255 [U8775096]

The HSMT-Flex scanner also has one slidable side frame. This feature enables probes to be mounted on the outside of the scanner, providing a configuration that is suitable for hard-to-reach places such as pipe-to-component welds.

Probe Holder Kits

Set of two spring-loaded arms (SLA) mounted on 90° brackets to accommodate more than four probes.

Standard: for pipes larger than 12 in. OD.

P/N: OPTX666 [U8775011]

Pivoting: for pipes smaller than 12 in. OD.

P/N: OPTX0717 [U8775095]

Spare Parts Kits

For UT+TOFD applications

P/N: OPTX686 [U8775020]

For PA+TOFD applications

P/N: OPTX690 [U8775022]

Features

- A folding aluminum frame to optimize probe contact on pipes for circumferential weld inspection.
- Four plastic-covered magnetic wheels which hold the unit against a ferromagnetic inspection surface.
- Compact and versatile; the provided frame bars offer size customization.
- Supports up to four conventional UT or phased array probes on pipes.
- Supports up to eight conventional UT or phased array probes on pipes bigger than 12 in. OD using the optional standard probe holder kit and on pipes ranging from 4.5 in. to 12 in. OD using the optional pivoting probe holder kit.
- Independently positioned, spring-loaded probe holders.
- One waterproof, spring-loaded encoder with a 12 steps/mm resolution.
- Removable handles for a lower profile.
- An eyelet for umbilical attachment.
- An integrated water manifold simplifies couplant distribution.
- Metric/US Customary unit rulers on the scanner frame for easy probe separation measurement.

Standard Inclusions

- Scanner frame with handles and:
 - Two 340 mm (13.5 in.) frame bars.
 - Two 500 mm (20 in.) frame bars.
- Four plastic-covered magnetic wheels.
- One waterproof, spring-loaded wheel encoder with 5 m cable.
- Four 90° probe holder brackets.
- Four spring-loaded arms (SLA).
- Four TOFD-P/E 31.75 mm yokes.
- Two PA 40 mm × 38 mm yokes.
- Two 55 mm yoke arm pairs
- Irrigation tubing and accessories.

Note: the umbilical cable, probes, and wedges are not included with the scanner.

Specifications

Length in Scan Axis (mm)	Width (mm)	Height (mm)	Weight (kg)
263	466	147	4.4



The hinged design of the HSMT-Flex scanner makes it possible to inspect pipes as small as 4.5 in. OD.

RollerFORM® Phased Array Wheel Probe



Features

- Exceptional coupling, requiring minimal couplant.
- Acoustic impedance similar to water.
- 25 mm water delay line enables inspection of composites up to 50 mm thick.
- Up to 51.2 mm wide beam coverage.
- Can be used in accordance with existing aircraft manufacturer procedures.

Standard Inclusions

- Phased array probe with OmniScan connector.
- Waterproof encoder.
- Laser guide.
- Indexer and Start Acquisition buttons.
- Spare parts.
- Filling/spraying pump and tubing.

The RollerFORM® phased array wheel probe is designed to address the inspection of composites and other smooth-surfaced materials commonly used by the aerospace industry. An affordable and easy-to-implement replacement for full 2D encoding systems, the RollerFORM probe also offers a viable alternative to immersion techniques.

The probe's unique tire material has been specifically developed to provide high-quality, immersion-like ultrasonic testing. Minimal couplant and pressure are required to provide excellent coupling and a strong signal, even in difficult scanning positions.

Just Roll It for Instant Results

The RollerFORM probe, combined with an OmniScan or FOCUS phased array instrument, uses zero-degree ultrasonic beams for manufacturing and maintenance inspections. Common applications include delamination sizing and porosity quantification in composite core material as well as wall-loss monitoring in aluminum panels. With its integrated indexing button, the ergonomically designed RollerFORM probe enables you to map the surface of an inspected material by acquiring multiple one-line C-scans and combining them in real time into a single image. The built-in laser guide facilitates straight and precise one-line scans.

In addition to providing exceptional coupling, the probe's tire is made of a unique material that closely matches the acoustic impedance of water. This design feature permits the efficient transmission of energy to the part without unwanted echoes, obtaining an optimum 1 mm near-surface resolution in composites when using the 5 MHz phased array probe model. The 3.5 MHz phased array probe model is better suited for certain thicker, more attenuating materials. Since the tire is transparent, you can easily identify the presence of air bubbles or contaminants within the water chamber.

Specifications

Description	Value
Typical Near-Surface Resolution (3 x 3 mm delamination)	1 mm at 5 MHz 1.5 mm at 3.5 MHz
Position of Repeat Interface Echo (in composite)	50 mm
Minimum Surface Curvature (convex radius)	50 mm
Dimensions (L x W x H)	235 mm x 145 mm x 150 mm (9.3 in. x 5.7 in. x 5.9 in.)
Weight (without water)	1.5 kg

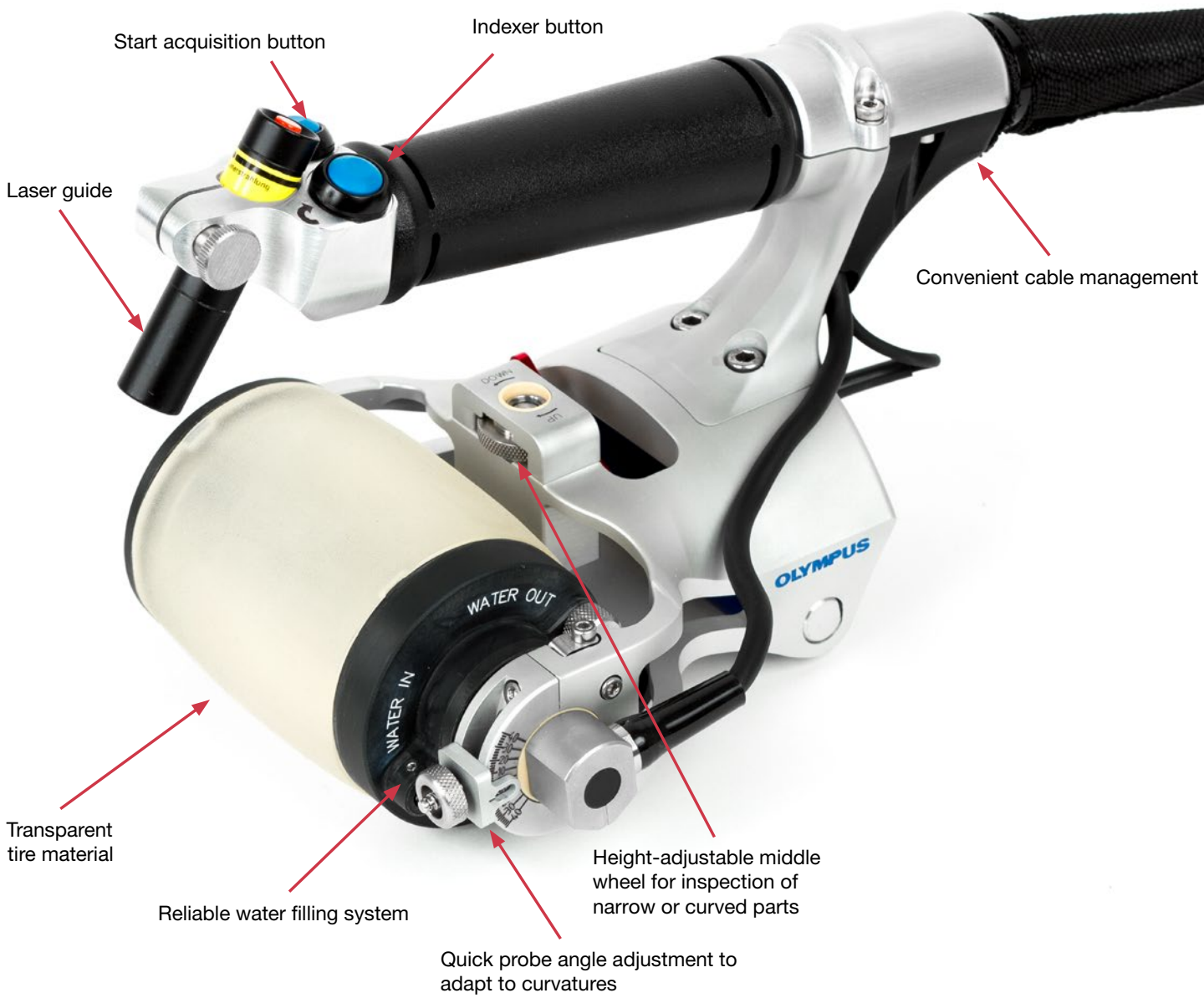

Ordering Information

Part Number	Item Number	Frequency (MHz)	Delay Line Height (mm)	Number of Elements	Pitch (mm)	Active Aperture (mm)	Elevation (mm)	Probe Casing Model	Cable Length (m)
RollerFORM-3.5L64	U8775334	3.5	25	64	0.8	51.2	6.4	IWP1	2.5
RollerFORM-5L64	U8775335	5	25	64	0.8	51.2	6.4	IWP1	2.5
RollerFORM-3.5L64-5M	U8778683	3.5	25	64	0.8	51.2	6.4	IWP1	5
RollerFORM-5L64-5M	U8778684	5	25	64	0.8	51.2	6.4	IWP1	5

HydroFORM®/RexoFORM™ Scanner for Corrosion Mapping



The HydroFORM and RexoFORM scanners are designed to offer the best inspection solution for the detection of wall-thickness reductions due to corrosion, abrasion, and erosion. Our solution also detects mid-wall damage such as hydrogen-induced blistering or manufacturing-induced laminations and easily differentiates these anomalies from loss of wall thickness.

The unique quick adjustment device offered by both scanners enables the wedge/probe assembly to be positioned to any curvature greater than 4 in. OD (101 mm).

Specification Comparison

	HydroFORM	RexoFORM
Phased array probe	I4	A12, A14
Maximum one-line scan coverage (width)	60 mm	38 mm (A12), 60 mm (A14)
Delay line medium	Water	Rexolite
Delay line height	14 mm or 24 mm	20 mm
Position of repeat interface echo (in steel)	125 mm	50 mm
Typical near-surface resolution (1/8 in. FBH)	1.5 mm	2 mm
Depth resolution	0.1 mm	0.1 mm
OD inspection range	4 in. and greater	4 in. and greater
ID inspection range	10 in. and greater	N/A
Contact device	Wheels	Carbides
Footprint	110 mm x 130 mm	40 mm x 95 mm
Scan direction	Circumferential	Circumferential
Scan speed (1 mm x 1 mm resolution)	100 mm/s	100 mm/s
Scanner compatibility	ChainSCANNER	ChainSCANNER, GLIDER, and VersaMOUSE

Features

- The first commercially-available, semi-automated phased array product for corrosion mapping applications.
 - Reduced probe raster movement increases safety for operators and improves mechanical reliability.
- The patent-pending quick radius adjustment enables the inspection of different curvatures. No wedges are needed.
 - Convex surface: 4 in. OD, up to flat.
 - Concave surface: 10 in. ID, up to flat (HydroFORM).
- The HydroFORM and RexoFORM scanners can be attached to automated or semiautomated scanners and used independently as manual scanners.
- Cost effective.
- Minimal tools required for normal operation.

Standard Inclusions

The HydroFORM manual corrosion mapping scanner kit includes:

P/N: HYDROFORM-K-MANUAL [U8775182]

- One probe holder with a water delay line.
- One carriage with four magnetic wheels.
- One phased array probe. (7.5L64-I4-P-7.5-OM)
- 100 foam gaskets.
- One application-specific Mini-Wheel™ encoder.
- One 7.5 m encoder cable extension.
- Irrigation tubing and accessories.

The RexoFORM manual corrosion mapping scanner includes:

P/N: REXOFORM [U8775241]

- One probe holder with a Rexolite® delay line.

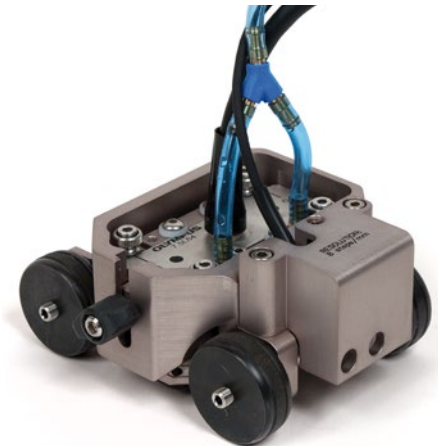

A patent-pending quick radius adjustment enables inspection of different curvatures without the need for wedges. The HydroFORM scanner also has an integrated encoder, which is required for manual inspections.

HydroFORM® Scanner

High-performance corrosion mapping for rough and uneven surfaces

The HydroFORM scanner uses an innovative water column that eliminates the need for a wedge, providing the benefits of a phased array immersion tank inspection. Easy gate synchronization with the front wall enables accurate backwall corrosion monitoring and remaining wall thickness measurements. The water column, which uses a low-flow water supply and consumable gaskets, offers excellent surface conformance and optimized coupling conditions, even on rough surfaces.

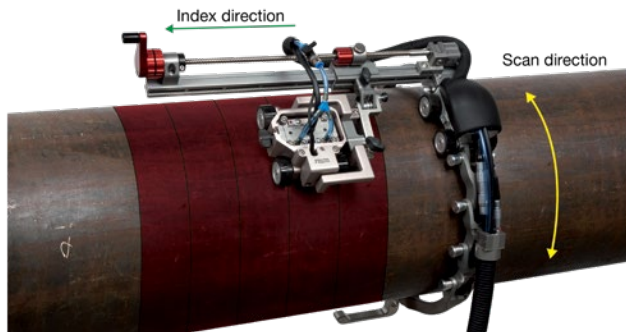

XY mapping principle on pipes with the HydroFORM scanner and ChainSCANNER™ scanner.

RexoFORM™ Scanner

Quick and easy corrosion mapping for smooth surfaces and limited-access areas

The RexoFORM scanner is a versatile wedge for phased array zero degree and angle beam inspection with a Rexolite® delay line. With its unique design, the RexoFORM scanner can be used on pipes of different diameters without the need for multiple curved wedges. It is also compatible with the A12 and A14 probes you may already have, making it an affordable solution.

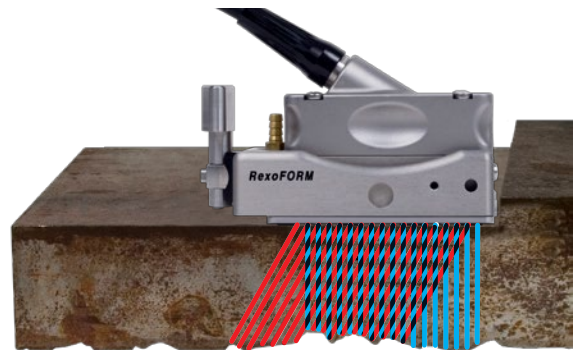

Example of beam possibilities with the RexoFORM scanner and A14 probe.

Ordering Information

Part Number	Item Number	Description	HYDROFORM-K-ADPCHAIN (U8750058)
HYDROFORM			
HYDROFORM-K-MANUAL	U8775182	HydroFORM corrosion mapping scanner kit	✓
HYDROFORM-A-ADPCHAIN	U8775183	Kit for adapting the HydroFORM to the ChainSCANNER	✓
HydroFORM-K-SAUT	Q750007	HydroFORM kit compatible with the MapSCANNER	
HydroFORM-K-AUT	Q7750068	HydroFORM kit compatible with the MapROVER 7.5 m	
HydroFORM-K-AUT-30m	Q7800018	HydroFORM kit compatible with the MapROVER 30 m	
HYDROFORM-SCN	U8750059	Same content as the HYDROFORM-K-MANUAL, without the phased array probe	
HYDROFORM-A-LITEHOLDER	U8840177	HydroFORM lite holder to mount the HydroFORM on GLIDER scanner using the optional ADIX893 (U8775084) yoke	
CFU03	U8780008	Electric water pump and tubing; 120 V and 220 V	
HYDROFORM-SP-FOAM	U8775184	100 foam gasket spare part kit	
REXOFORM			
REXOFORM	U8775241	The RexoFORM corrosion mapping probe holder with the Rexolite delay line for use with A12 or A14 probes	
ENC1-5-LM	U8780198	Mini-Wheel™ encoder with 5 m long cable	
REXOFORM-SP-WEDGE	U8775242	Spare Rexolite delay line and gasket for RexoFORM	

FlexoFORM™ Scanner for Pipe Elbow Inspection



The FlexoFORM™ scanner solves the challenges of pipe elbow inspection and enables 100% coverage with intuitive C-scan imaging. Incorporating Olympus' flexible array probe technology, the FlexoFORM scanner solution can map corrosion in pipe elbows from 4.5 in. OD and up. The FlexoFORM scanner features a water column with a foam gasket that contours to the pipe's inner concave (intrados) and outer convex (extrados) curves, for optimum coupling and a reliable signal. The flexible array is shaped by the wedge to sit concentric to the elbow's surface, enabling the use of simple 0-degree focal laws, similar to inspecting a flat surface. The water wedge can be changed in seconds and is the only part that differs from one diameter to the other. The scanner and flexible probes are designed to cover the entire range of diameters, making the FlexoFORM scanner a versatile and cost-effective solution.

Wedge series have also been designed for small-diameter pipes and automated scanning.



Features

- Quickly measure the wall thickness of elbows
- 100% elbow coverage for a high probability of detection
- High-resolution data (1 mm × 1 mm)
- Intuitive 2D C-scan imaging
- Built-in encoder for scan direction
- Smart indexer button positioned on the scanner
- Same probe and scanner are used to cover the entire range of diameters
- Magnetic wheels minimize the operator's physical input
- Water wedges for a wide range of pipe diameters
- Constant water column

Alternative Configurations



SFA1-FLEXO longitudinal scanning of pipes

The FlexoFORM scanner can also inspect pipes in the longitudinal direction. This configuration is especially useful for smaller pipes or when the region of interest is concentrated within a specific sector around the pipe. The FlexoFORM scanner can also be a powerful tool for the inspection of water walls in power generation boilers.



SFA1-SMALL wedge series for small-diameter pipes

These wedges are used to inspect pipes with diameters smaller than 4.5 in. Users can manually scan the extrados of elbows or pipes from 1.3 in. OD up to 4 in. OD. The wedge can be fitted with a Mini-Wheel™ encoder to create an encoded one-line scan.



SFA1-AUTO wedge series for automated 2D raster scanning

For 100% inspection of corrosion in pipes, the HydroFORM® scanner, when combined with the MapROVER™ scanner, represents a field-proven, reliable option. However, in some applications, scanning in the longitudinal direction may be preferred over scanning circumferentially. The SFA1-AUTO wedge series works on pipes with diameters from 8.6 in. OD and up, including flat surfaces.



Ordering information and glossary

Item Number	Part number	Description
Q7500062	FlexoFORM	FlexoFORM package with probe and one (1) SFA1 water wedge for 8.625 in. outside diameter. 5 m long cables compatible with current generation OmniScan and FOCUS instruments.
Q7500063	FlexoFORM-Kit	FlexoFORM package with probe and six (6) SFA1 water wedges (for 4.5 in., 6.625 in., 8.625 in., 10.75 in., 12.75 in., and 16 in. outside diameters). 5 m long cables compatible with current generation OmniScan and FOCUS instruments.
Q3301202	7.5L64-64X7-FA1-P-5-OM	Flexible phased array probe, 7.5 MHz, 64 elements, 1 mm pitch, 7 mm elevation, FA1 case type for the FlexoFORM scanner, SFA1-SMALL and SFA1-AUTO wedge series, 5 m cable length, and OmniScan connector.

Probe Type	Wedge Series	Pipe Diameter
SFA1	FLEXO	OD8.625

FLEXO Compatible with FlexoFORM. Diameter range: 4.5in OD up to flat.

AUTO Compatible with MapROVER and SteerROVER. Diameter range from 8.625in OD up to Flat.

SMALL Manual inspection with Mini-Wheel encoder. Diameter range from 1.3in up to 4in OD.

Measured external pipe diameter (inches)

Motorized One-Axis Scanner

WeldROVER™ Scanner for Weld Inspection



The WeldROVER™ scanner is made for customers who require a more stable inspection than that provided by manual scanners and who want a more economical package than that of the high-production zone-discrimination systems typically used in offshore pipeline construction.

The WeldROVER simple, industrial-strength, one-axis encoded scanner provides you with fully mechanized automated data acquisition. It is designed to perform fast and efficient phased array inspections on ferromagnetic piping or vessel girth welds and long seams with minimum training and setup time. The scanner can be configured with up to six probes for phased array, TOFD, and conventional UT inspection.

1 Interface with TomoScan FOCUS LT™ can be achieved using the optional encoder cable adaptor.

Configurations

A typical configuration for compliance with ASME codes is two PA probes and one or two pairs of TOFD probes.

Circumferential scan

- Supports two probes at the back and two probes at the front of the scanner on pipes from 4 in. OD and greater.
- Supports up to four probes at the front of the scanner on pipes from 12 in. OD and greater.

The WeldROVER scanner is easy to use. It is operated by a simple two-button remote control with variable speeds. The scanner directly interfaces with OmniScan® or FOCUS instruments without the need for complex software, motion controller electronics, or configuration. The laser guide indicator helps the operator manually adjust the scanner direction using the steering lever. This allows precision data to be acquired without the need for guide bands, complex tracking systems, or motorized steering capability. It is a perfect fit for companies offering fully mechanized, automated phased array (AUT) inspection services and requires less than one hour of training for those individuals who have completed the basic OmniScan course.

- Supports up to six probes at the front of the scanner on pipes from 16 in. OD and greater.

Longitudinal scan

- Supports up to six probes at the front of the scanner on pipes from 30 in. OD and greater.

Note that on smaller pipes, the probe separation distance will be limited.

Features

- Can support up to six probes for TOFD, phased array, or pulse-echo inspections.
- Constant scanning speed control for smooth data acquisition at any speed.
- Compact motion controller offering 10 different scan speeds from 5 mm/s to 50 mm/s.
- Simple two-button remote control for jog or constant encoded motion in either the backward or forward direction.
- Performs data acquisition using OmniScan or FOCUS¹ instruments with less than five minutes configuration time.
- The four industrial-strength magnetic wheels for use on ferromagnetic surfaces.
- Integrated water manifold for simple and efficient couplant delivery.
- Emergency-stop button located on the scanner.
- A laser guide indicator to help the operator follow the weld centerline or any other inspection reference.
- Room to integrate a remote pulser/preamplifier for improved TOFD-P/E inspections.
- Divisible cable conduit umbilical offers cable protection and configuration flexibility. Minimal time needed for probe reconfiguration.
- Waterproof (IP65).

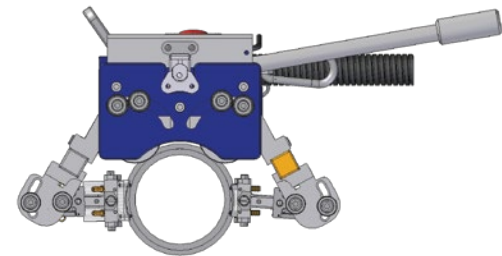

Supports two probes at the back and two probes at the front of the scanner on pipes from 4 in. OD and greater.

Standard Inclusions

- One motorized scanner with rotating probe-holder arms at the front and back of the scanner.
- Two probe holder frame bars of 200 mm (8 in.) and one of 430 mm (17 in.).
- Remote control with a 5 m cable.
- MCDC-01: one-axis DC motion controller.
- Power supply.
- Encoder cables linking the MCDC-01 to the OmniScan®.
- Six spring-loaded arms (SLA), pivoting probe holders, and all the brackets needed for the different configurations.
- Four TOFD-P/E 31.75 mm yokes.
- Two PA 40 mm x 55 mm yokes.
- Two PA 40 mm x 65 mm yokes for PWZ1 and A14 probes.
- Two PA 40 mm x 46 mm yokes.
- Laser guide and holder.
- Two steering levers.
- One 5 m divisible conduit for cable protection and attachment to the scanner.
- Irrigation tubing and fittings.
- Scanner and accessory carrying case.

Note: All cables for scanner operation are 5 m. Probes and wedges are not included with the scanner. The WeldROVER can also be optionally delivered with 10 m cables.

Options

Couplant-Feed Units

See the accessories section on page 33.

Remote Pulsar/Preamplifier

See the accessories section on page 28.

Extra Spring-Loaded Probe Holder

P/N: WELDROVER-A-SLA [U8775125]

Extra Laser Guide

P/N: WELDROVER-A-LASER [U8775124]

Instrument case

Modular instrument and accessory hard carrying case. The modules can be used to transform the scanner case into a workstation.

P/N: WELDROVER-A-ICASE [U8775123]

Yokes

See the accessories section on page 34.

Spare Parts Kit

Basic spare part kit for the WeldROVER scanner.

P/N: WeldROVER-A-SPKit [U8775122]

P/N: WeldROVER-A-SPKit-10M [U8775149]

Data acquisition can be handled completely by an OmniScan flaw detector (not included in WeldROVER package)

Laser guide for better weld tracking

Integrated water manifold simplifies couplant distribution

Room to integrate a remote pulsar/preamplifier for improved TOFD and PE inspections

Eyelet for lanyard attachment

Emergency-stop button

Steering lever to manually adjust the scanner direction

MCDC-01: one axis DC motion controller

Independently spring-loaded arm (SLA) probe holders

Four driven magnetic wheels firmly hold the scanner against a ferromagnetic inspection surface

Divisible cable conduit umbilical for cable protection and attachment to scanner

Easy to operate using a simple remote control featuring 2 push-buttons and one rotary switch

Light and compact aluminum frame

Rotating probe-holder arms for adaptation to different diameters

Specifications

Scanner speed: 5 mm to 50 mm per second

Encoder resolution: 2100 steps/mm (typical)

Power consumption: 90 W

Maximum input current: 4 A

Voltage: 24 VDC

Power supply input voltage:
100 VAC to 240 VAC; autoswitching

Component	Length (mm)	Width (mm)	Height (mm)	Weight (kg)
Scanner with long bar and six probes	430	380	175	12.0
Scanner with small bars and four probes	380	200	175	11.0
MCDC-01 motion controller	175	110	60	1.5
Power supply	200	85	50	1.0
Remote control	230	50	90	0.8

Motorized Two-Axis Scanner

MapROVER™ Scanner for Corrosion Mapping



Thanks to its two motorized axes, the MapROVER scanner offers improved productivity. Easily control the scanner with the touch screen remote control, which eliminates the need for a computer or complex motor-controller programming. When combined with the HydroFORM® phased array corrosion mapping solution, the MapROVER is a very powerful tool for C-scan imaging of remaining wall thickness and mid-wall anomalies. When used with the OmniScan® SX UT flaw detector for conventional dual UT inspection, the MapROVER scanner is a cost-effective and simple option over the more complex systems.

Ordering information

Part number	Item Number	Description
MapROVER	Q750003	MapROVER scanner kit with 7.5 m long cable
MapROVER-30m	Q7800017	MapROVER scanner kit with 30 m long cable
HydroFORM-K-AUT	Q7750068	7.5 m HydroFORM with PA probe, buggy and encoder
HydroFORM-K-AUT-30m	Q7800018	30 m HydroFORM kit with PA probe, buggy and encoder
D790-SM	U8450009	Dual UT probe D790-SM
ABWX612	U8700372	Economical fixture for D790 dual UT probe
MapROVER-A-D790-ProbeHolder	Q7750070	Rugged fixture for D790 dual UT probe
C174-LM-UDOT-7.5M	Q7670010	7.5 m UT cable (Lemo-00 to Udot)
C174-LM-UDOT-30M	Q7670011	30 m UT cable (Lemo-00 to Udot)
MapROVER-A-weldkit-2probes-V2	Q7750114	Weld probe holder kit for 2 probes with PA and TOFD arms
MapROVER-A-weldkit-4probes	Q7750083	Weld probe holder kit for 4 probes with 2 PA + 2 TOFD probe holders

Features

- Four magnetic wheels that are motorized for constant data acquisition up to 147 mm/s.
- Motorized raster arm enabling 600 mm scan width travelling at a speed up to 900 mm/s.
- Touch screen remote control with two joysticks, enabling users to perform jog or constant encoded motion as well as two different choices of complete automatic raster scan patterns.
- Performs data acquisition using OmniScan or FOCUS instruments with less than five minutes configuration time.
- Cable management system for increased reliability.
- Emergency-stop button located on the scanner and on the power supply.
- Divisible cable conduit umbilical offers cable protection and configuration flexibility.
- Handle for scanner manipulation and umbilical attachment.

Standard Inclusions

- Nonsteerable motorized scanner.
- Motorized raster arm 600 mm long.
- Spring loaded probe holder compatible with the HydroFORM® scanner and Dual Linear Array™ (DLA) probe.
- Touch screen remote control.
- One skew arm to assist scanner direction.
- Power controller.
- Detachable umbilical cables with divisible protection sleeve.
- Encoder cable linking to OmniScan instruments.
- Carrying case.

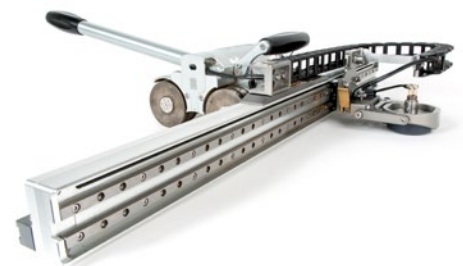

The MapROVER scanner is also capable of inspection using dual element conventional UT probes. When combined with the OmniScan SX UT instrument, this alternative solution is quite affordable.

Configurations

The standard MapROVER scanner application is for corrosion mapping. For greater versatility, it can also be fitted with an optional probe holder kit for weld inspection.

Corrosion mapping

- A motorized raster arm comes standard for a 600 mm wide travel distance.
- Standard probe holder compatible with the HydroFORM® scanner or D790 dual conventional UT probe when using the optional probe fixture and cables.

Weld inspection

- An optional probe holder rack can be mounted on the scanner for a one-line scan.

Only the kit for 2 probes can be mounted on the raster arm.

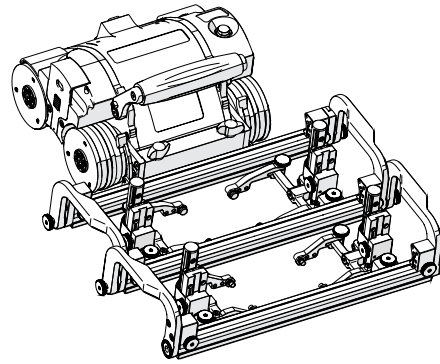
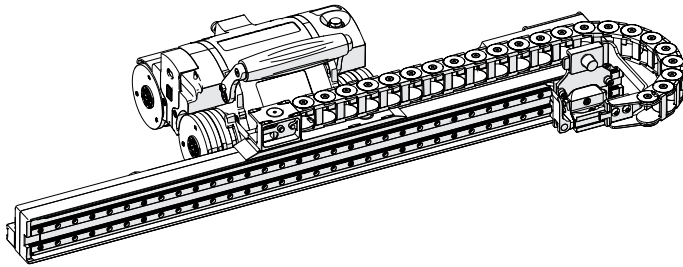

Specifications

Maximum scanner speed	142 mm/s
Maximum raster arm speed	900 mm/s
Scanner resolution	1354 steps/mm
Raster arm resolution	240.2 steps/mm

OmniScan® acquisition unit



Touch screen remote control



Motorized scanner with 4 magnetic wheels

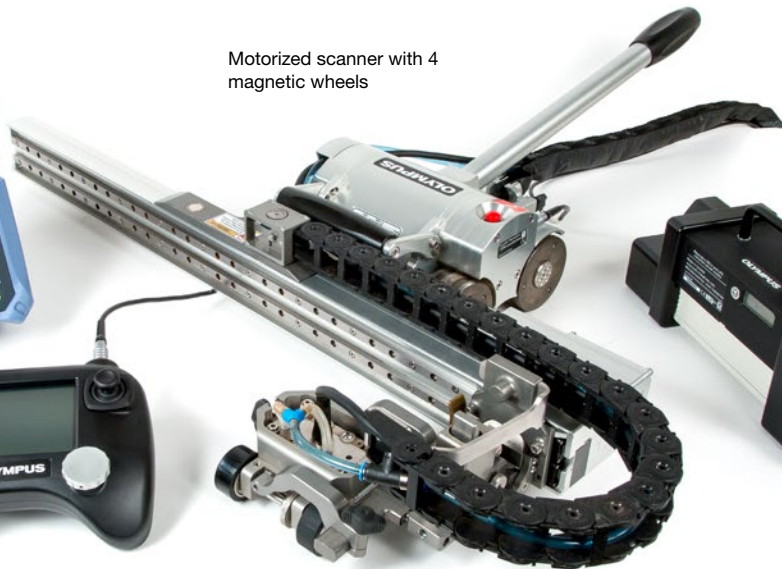

HydroFORM scanner and holder assembly

Motorized raster arm

Power controller



SteerROVER™ Scanner for Weld Inspection and Corrosion Mapping



The SteerROVER™ portable motorized scanner is based on the field-proven MapROVER™ scanner, but adds steering capabilities so that users can position it from a distance. This functionality is useful when inspecting large ferromagnetic surfaces, such as pressure vessels and tanks, where the area to be inspected is out of the operator's reach. The scanner can be configured for corrosion mapping with a motorized raster arm or for weld inspection (both longitudinal and circumferential) with a probe holder rack. The scanner is controlled using an intuitive touch screen remote control, so there is no need to bring a laptop to the inspection site. The only connection is between the power controller and the OmniScan® or FOCUS PX™ flaw detector's encoder input.

Configurations

The SteerROVER scanner can be ordered in different configurations depending on the application (weld or corrosion) and by combining different raster arm and cable length options.



The SteerROVER scanner and probe holder rack can bend to perform inspection of longitudinal welds.



The SteerROVER scanner, when fitted with a motorized raster arm, is a powerful solution for corrosion inspection in remote locations.

Features

- Steerable scanner comprised of two pods with independent motors and four strong magnetic wheels.
- Touch screen remote with two joysticks; configure so that scanner movement requires constant user input (jog) or so that one input starts the scanner and a second stops it.
- Two complete automatic raster scan patterns are available.
- Can be ordered with two choices of motorized raster arms for corrosion inspection or a probe holder rack for weld inspection with four probes (increase to six probes with optional probe holders).
- Emergency-stop buttons located on the scanner and on the power controller.
- Divisible cable conduit umbilical offers cable protection and flexible configurations.

Standard Inclusions

- Steerable motorized scanner.
- Touch screen remote control.
- Power controller.
- Detachable umbilical cables with divisible protection sleeve.
- Encoder cable linking to current generation OmniScan and FOCUS instruments.
- Irrigation tubing.
- Carrying case(s).
- Motorized raster arm or probe holder rack (depending on configuration).

Motorized raster arm:

- Spring-loaded probe holder compatible with the HydroFORM® scanner and Dual Linear Array™ corrosion probe.

Pivoting probe holder rack:

- Four spring-loaded probe holders.
- Two adjustable yokes to hold phased array probes (up to 57.6 mm wide and 48.5 mm long).
- Two adjustable yokes to hold TOFD-P/E probes (up to 45 mm wide and 36.8 mm long).

Specifications

Circumferential pipe diameter range	2.75 in. (70 mm) up to flat
Longitudinal pipe diameter range	12 in. (305 mm) up to flat
Internal, circumferential pipe range	24 in. (610 mm) and up
Maximum scanner speed	250 mm/s
Maximum raster arm speed	762 mm/s
Scanner idler encoder resolution	13.78 steps/mm
Scanner motor encoder resolution	872.5 steps/mm
Raster arm resolution	240.2 steps/mm

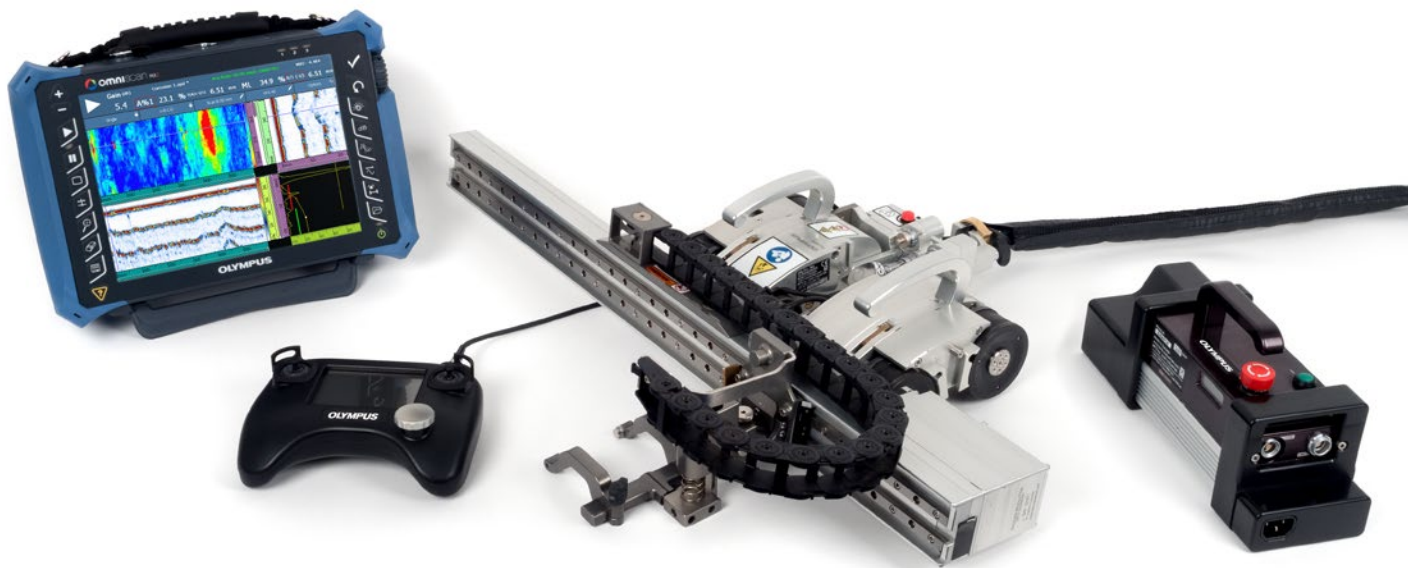

Ordering Information

Part number	Item Number	Description
SteerROVER-Weld-5m	Q7500050	SteerROVER scanner with weld probe holder rack. 5 m (16 ft) long cables.
SteerROVER-Weld-15m	Q7500051	SteerROVER scanner with weld probe holder rack. 15 m (49 ft) long cables.
SteerROVER-Weld-30m	Q7500052	SteerROVER scanner with weld probe holder rack. 30 m (98 ft) long cables.
SteerROVER-Raster600-7.5m	Q7500053	SteerROVER scanner with 600 mm (2 ft) long raster arm. 7.5 m (24.6 ft) long cables.
SteerROVER-Raster600-15m	Q7500054	SteerROVER scanner with 600 mm (2 ft) long raster arm. 15 m (49 ft) long cables.
SteerROVER-Raster600-30m	Q7500055	SteerROVER scanner with 600 mm (2 ft) long raster arm. 30 m (98 ft) long cables.
SteerROVER-Raster900-7.5m	Q7500056	SteerROVER scanner with 900 mm (3 ft) long raster arm. 7.5 m (24.6 ft) long cables.
SteerROVER-Raster900-15m	Q7500057	SteerROVER scanner with 900 mm (3 ft) long raster arm. 15 m (49 ft) long cables.
SteerROVER-Raster900-30m	Q7500058	SteerROVER scanner with 900 mm (3 ft) long raster arm. 30 m (98 ft) long cables.
MapROVER-A-Laser	Q7750081	Optional laser guide to be used with the probe holder rack.
SteerROVER-A-CameraMount	Q7201259	Optional camera mount support.
SteerROVER-A-PivotingWeldRack	Q7201258	Pivoting probe holder rack to add weld inspection capability to a SteerROVER-Raster package.
MapROVER-SP-VPH-PA	Q7750121	Vertical probe holder for phased array probe.
MapROVER-SP-VPH-TOFD	Q7750126	Vertical probe holder for TOFD probe.
MapROVER-A-D790-ProbeHolder	Q7750070	Rugged probe holder and mounting fixture for D790-SM dual UT probe.

Manual Two-Axis Scanner

ChainSCANNER™ Solution for Pipe Inspection



The versatile ChainSCANNER two-encoded axes manual pipe-inspection solution works on pipes with outside diameters from 1.75 in. to 38 in. (45 mm to 965 mm). The scanner, which is held by chain links instead of magnetic wheels, is capable of inspecting ferromagnetic or nonferromagnetic surfaces. The chain links help ensure a straight displacement of the scanner by eliminating steering problems. It is also very useful when the area around the pipe is not entirely accessible, as the scanner can be rotated by pulling on the chain links.

Main applications

- Circumferential pipe weld inspections with phased array, TOFD, or conventional UT (pictured above).
- Corrosion mapping in conjunction with the HydroFORM® phased array solution (pictured below).



Features

- Standard configuration using one or two probes, and optional configuration using four probes for TOFD, phased array, or pulse-echo inspections.
- A pipe range with outside diameters from 1.75 in. to 38 in. (45 mm to 965 mm).
- An encoded manual scan with up to two axes.
- Ergonomic handle to protect encoder connectors and provide cable management.
- Independent chain links are mounted on bearing wheels coated with urethane for smooth rolling.
- An easy clamping device for quick scanner positioning.
- Spring-loaded probe holders that ensure good probe contact in any scanner position or orientation.
- The majority of adjustments can be made without the use of tools.

Standard Inclusions

- Main module with a scan-axis encoder.
- Encoded probe-positioning system with lead screw adjustment.
- Chain links for up to 38 in. pipe ODs, with a quick-release adjustable buckle.
- One 5 m (16 ft) encoder cable.
- One 450 mm (17.7 in.) probe-holder bar.
- Two spring-loaded probe holders with two adjustable PA yokes.
- Two adjustable TOFD-P/E yokes.
- One 5 m divisible cable conduit (19 mm ID).
- Cable conduit attachment fixture.
- Irrigation tubes and fittings.
- A ChainSCANNER custom tool.
- A carrying case.

Note: probes and wedges are not included with the scanner.

Main Module Specifications

Length in Scan Axis (mm)	Width (mm)	Height (mm)	Weight (kg)
114	75	84	1

Encoder resolution:

Circumferential (X) axis: 19.2 steps/mm.

Longitudinal (Y) axis: 226.8 steps/mm.

Options

Remote Pulser/Preamplifier

See the accessories section on page 28.

Couplant-Feed Units

See the accessories section on page 33.

Arm Stabilizer

ChainSCANNER™ arm stabilizer kit. Includes a magnetic wheel block and the holder.

P/N: ChainScan-A-Stabilizer [U8775210]

Chain Links

Extra ChainSCANNER short link. Required on pipe ODs less than 9.6 in.

P/N: ChainScan-A-SLink [U8775127]

Extra ChainSCANNER long link. To be used on pipe ODs greater than 9.6 in.

P/N: ChainScan-A-LgLink [U8750042]

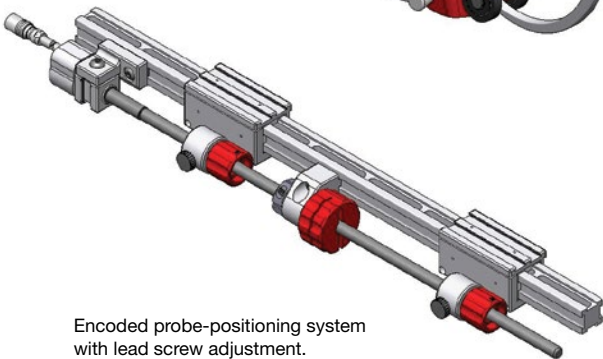

Encoded probe-positioning system with lead screw adjustment.

Additional Packages

Two Additional Probe Packages

Needed to perform inspections with four probes and a preamplifier on the ChainSCANNER.

P/N: ChainScan-A-4Probe [U8775128]

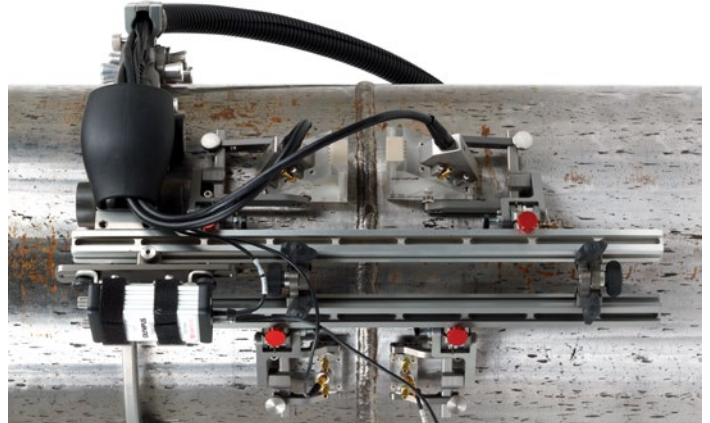

Mouse Package

Needed to use the ChainSCANNER solution as a mouse scanner with magnetic wheels holding the system instead of chain links.

P/N: ChainScan-A-Mouse [U8750037]

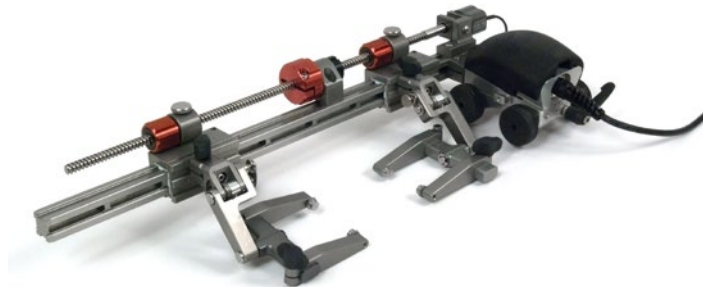

Short Bar Package

A 20 cm probe-holder bar and lead screw kit for restricted space applications.

P/N: ChainScan-A-SBar [U8775129]

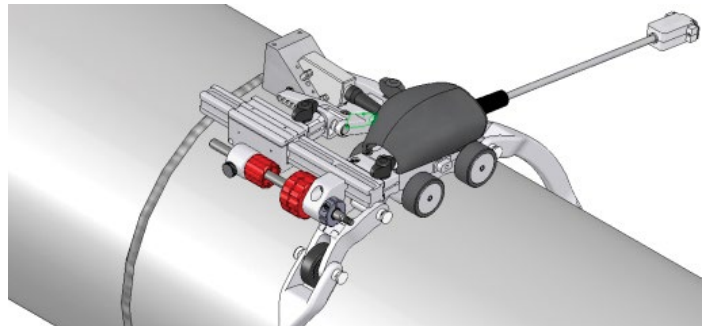

Ordering information

Part Number	Item Number	Description
ChainScan-XY38	U8750041	ChainSCANNER for 45 mm to 965 mm (1.75 in. to 38 in.) OD pipes with two encoded axes.
ChainScan-SP-Basic	U8779370	Basic spare part kit for the ChainSCANNER, which includes lead screw and lever for buckle, wedge pivot buttons, dovetail nuts, tool, plastic wheel, and screws.

MapSCANNER™ Solution for Corrosion Mapping

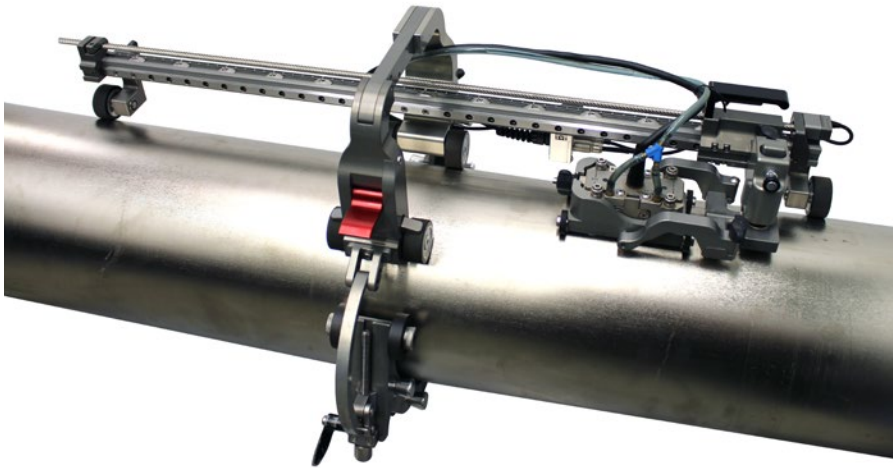

The innovative MapSCANNER manual scanner is designed for corrosion mapping inspections. With its wide scanning capability and quick indexing system, the MapSCANNER solution is the ideal scanner for high-production, phased array, semiautomated corrosion mapping inspections. It can be purchased with chain links or as an upgrade for the ChainSCANNER solution thanks to its compatibility with the chain links you may already own. The scanner can also be configured with magnetic wheels to inspect ferromagnetic parts where chain links are not required. When combined with the HydroFORM® scanner or Dual Linear Array™ (DLA) corrosion mapping solutions, the MapSCANNER solution is a powerful tool to efficiently perform C-scan imaging of remaining wall thickness and mid-wall anomalies.

Part number	Item Number	Description
MapSCANNER-ADPCHAIN	Q7500004	Manual scanner package upgrade from ChainSCANNER (without chain links and encoder cable)
MapSCANNER-LINKS	Q7500005	Complete manual scanner package including chain links
MapSCANNER-MAG	Q7500006	Complete manual scanner package with magnetic wheels
HydroFORM-K-SAUT	Q7500007	HydroFORM® water box with 7.5 m long cable PA probe
MapSCANNER-A-MAG	Q7750071	Conversion kit to convert a MapSCANNER compatible with chain links to a magnetic version
MapSCANNER-SP-Basic	Q7750090	Basic spare part kit
MapSCANNER-A-Link	Q7750146	Kit of links to transform a MapSCANNER-MAG into a MapSCANNER-LINK

Features

- Two-axis encoded scan.
- Quick indexing system with adjustable keys.
- Pass-through frame arch principle for greater scanning width.
- Stabilizer wheels at both ends of the frame bar.
- Brake system.
- Optional chain links mounted on bearing wheels coated with urethane for smooth rolling.
- A pipe range with outside diameters from 4 in. to 38 in. (102 mm to 965 mm) for the model using chain links.
- A pipe range with outside diameters from 4 in. to flat (102 mm to flat) for the model using magnetic wheels.
- Spring-loaded probe holders that ensure good probe contact in any scanner position or orientation.

Standard Inclusions

- Adjustable spring-loaded probe holder.
- HydroFORM water box-specific cart with wheels.
- 7.5 m encoder cable for OmniScan® flaw detectors with a zipper type cable protection sleeve (not included in MapSCANNER-ADPCHAIN).
- Frame bar good for 580 mm wide inspection.
- A carrying case.



A version of the MapSCANNER solution is available for use on ferromagnetic surfaces of 4 in. OD to flat.

GLIDER™ Scanner for Composite Inspection



Photo used with the permission of Avior, Produits Intégrés

The GLIDER™ X-Y, two-axis encoding scanner is used for manual inspection of slightly curved or flat composite surfaces.

Commonly inspected materials include composites and aluminum using suction-cup pods and carbon steel using optional magnetic pods.

Applications

- Inspection of composites.
- Inspection of airplane fuselages for delamination and cracking.
- Inspection of ferromagnetic plates for corrosion.
- Inspection of friction stir welds (FSW) on aluminum.

Options

Magnetic accessories package

Magnetic mounting pods and Y-axis support enable use on ferromagnetic surfaces.

P/N: GLIDER-A-01 [U8775058]

Yokes

See the accessories section on page 34.

Couplant-Feed Units

See the accessories section on page 33.



Interchangeable mounting pods (magnetic pods are optional).

Features

- Well-suited to phased array, conventional UT, and eddy current inspection techniques using one probe.
- Two axes with waterproof encoders for position-encoded X-Y scans.
- Axis positioning with minimal backlash.
- Both modules are mounted on bearings for precise and smooth displacement.
- Two pivot-equipped mounting pods enable surface following.
- Locking devices for each axis.
- Module displacement can be in increments of 3.27 mm, or in free-running mode.
- The probe holder is mounted on a bearing-arm system that can be spring loaded if needed.
- An aluminum frame is used for lightweight and rust-free components.
- The Y axis can be easily shortened for smaller surface radius inspection or removed for easier transport.

Standard Inclusions

- Two tracks (18 in., 24 in., or 36 in., depending on the model).
- Two displacement-encoding modules.
- Two suction-cup mounting pods.
- Two encoders with a 5 m cable.
- One PA 40 mm × 55 mm yoke.
- One TOFD-P/E 31.75 mm yoke.
- 90° probe holder mounting bracket.
- 180° probe holder mounting bracket.
- 45°, 90°, 180° adjustable probe holder mounting bracket.
- Probe holder bearing arm with spring.
- Irrigation tubing and fitting.
- A carrying case.

Note: the umbilical cable, probes, and wedges are not included with the scanner.

Specifications

Weight: 5 kg to 8 kg, depending on the configuration

Suction-cup pod holding force: 7 kg per cup

Magnetic-pod holding force: 81 kg per base

Encoder resolution: 13 steps/mm (±0.15 step/mm), 330 steps/in. (±0.006 step/in.)

Minimum curvature for partial scans: 50 cm (20 in.) OD

Ordering Information

Part Number	Item Number	Description	Length (X) (mm)	Width (Y) (mm)	Height (mm)
GLIDER-18X18	U8750001	GLIDER scanner with X-Y 457 mm × 457 mm stroke	700	690	152
GLIDER-24X24	U8750002	GLIDER scanner with X-Y 610 mm × 610 mm stroke	900	845	152
GLIDER-36X36	U8750003	GLIDER scanner with X-Y 914 mm × 914 mm stroke	1200	1150	152

Pulsers and Preamplifiers

TRPP 5810™ Pulsar/Preamplifier for TOFD Inspection



The TRPP 5810™ unit is a high-performance remote pulser/preamplifier dedicated to TOFD inspections and compatible with Olympus scanners.

This remote pulser/preamplifier provides an optimum signal-to-noise ratio for TOFD inspections by combining a 40 dB preamplifier with a remote high-voltage (200 V) pulse repeater in a single, small enclosure. The TRPP 5810 unit supports two UT channels, enabling simultaneous inspection with one or two pairs of TOFD probes. The TRPP 5810 unit can be used as a pulser and/or preamplifier.

TRPP 5810 Unit as a Pulsar

- Provides an additional pulse gain to generate a stronger signal, as needed, to reveal difficult-to-detect flaws.

TRPP 5810 Unit as a Preamplifier

- Provides the additional gain or broadband signal-to-noise enhancement necessary for optimum signal acquisition on thick sections of material exhibiting high ultrasonic attenuation.
- Enables long cables to be driven from remotely located sensors.

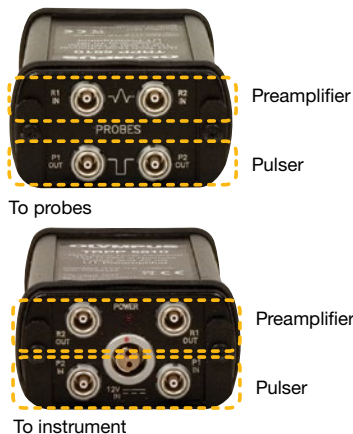

Ordering Information

Part Number	Item Number	Package Contents
TRPP-5810	U8120042	Pulsar/preamplifier, one 5 m power supply cable (120 VAC to 240 VAC input to 12 VDC output), one 5 m power supply cable linking to an OmniScan® flaw detector, and carrying case.
TRPP-5810-KIT01	U8120043	Same as P/N TRPP-5810, plus: Four 0.6 m UT probe cables (LEMO® 00 to Microdot™), and brackets to attach the TRPP 5810 unit to a HSMT-type scanner. (P/N: HSMT-A-BRK5810 [U8779088])
TRPP-5810-INST	U8775114	Same as P/N TRPP-5810-KIT01, plus: Four 5 m UT cables (LEMO 00 to LEMO 00) linking the TRPP 5810 unit to the instrument.
TRPP-5810-UMB	U8775113	Same as P/N TRPP-5810-KIT01, plus: Four 0.6 m UT cables (LEMO 00 to LEMO 00) linking the TRPP 5810 unit to the umbilical.

Features

- Dimensions (W × H × L): 57 mm × 32 mm × 90 mm (2.5 in. × 1.3 in. × 3.5 in.).
- Weight: 300 g.
- UT connectors: 8 × LEMO 00 female.
- Water/moisture resistance: NEMA 4-IP66. Rustproof.
- Powered by an external 12 VDC source or from the instrument.
- Power connector: Compatible with standard Olympus umbilical cables (male Fisher 103 type).
- A red power-on LED indicator.
- Operating temperature range: -10°C to 60°C (14°F to 140°F).

Specifications

Pulsar

- A remote, high-voltage (200 V) pulse repeater.
- PRF of up to 10 kHz at 100 ns per channel, and up to 20 kHz at 50 ns for a single channel.
- Pulsar-side outputs which protect against misuse and improper connection from the instrument outputs.

Preamplifier (Receiver)

- 40 dB preamplifier.
- Accommodates probe frequency ranges from 1 MHz to 15 MHz.
- Preamplifier side inputs and outputs are protected against misuse and improper connection from the instrument outputs.

Options

Power Cable

(from TomoScan FOCUS LT)

One 5 m power supply cable linking to the TomoScan FOCUS LT™ instrument..

P/N: TRPP-5810-A-01 [U8800488]

Power Cable (from OmniScan)

10 m power supply cable linking to the OmniScan® flaw detector.

P/N: TRPP-A-PWRC-OM-10M [U8775118]

Transformer and Cable

Transformer (120 VAC to 240 VAC input to 12 VDC output) with a 10 m power supply cable.

P/N: TRPP-A-PWRC-AC-10M [U8779168]

5682 Preamp for TOFD Inspection

The 5682 ultrasonic preamplifier provides low-noise amplification of ultrasonic signals (for one probe) ranging from 500 kHz to 25 MHz. The preamplifier, which is housed in a rugged splashproof enclosure, is very small and lightweight, making it ideally suited to remote applications. The preamplifier can be powered with either a single 9 V battery (included) for up to 50 hours of continuous operation or an optional 9 V to 13 V DC supply. When battery operated, a multicolored LED provides battery feedback status. This preamplifier is ideal for TOFD inspections.

Specifications

- 26 dB gain
- 50 hours of battery life (continuous discharge)
- A continuous power-level indicator
- 67 dB signal-to-noise ratio
- Weight: 180 g with battery



Ordering Information

Part Number	Item Number	Package Contents
5682	U8120006	5682 preamplifier and 9 V battery
5682-KIT01	U8120038	5682 preamplifier, one 2.5 m UT probe cable (LEMO® 00 to LEMO 00), one 2.5 m power supply cable linking to the OmniScan® flaw detector, and a belt case.
5682-KIT02	U8779091	5682 preamplifier, one 5 m UT probe cable (LEMO 00 to LEMO 00), one 5 m UT probe cable (LEMO 00 to Microdot), one 0.6 m UT probe cable (LEMO 00 to Microdot™), one 5 m power supply cable linking to the OmniScan® flaw detector, a belt case, and a bracket to attach the 5682 to HSMT-type scanners, the HST-Lite scanner, or the ChainSCANNER™ scanner (P/N: HSMT-A-BRK5682 [U8779089]).
5682-A-PWRC-OM-5M	U8775119	One 5 m power supply cable linking to the OmniScan flaw detector.
5682-A-PWRC-UMB-0.15M	U8779092	Power cable adaptor linking the 5682 preamplifier to the umbilical cable.

PR-06-04 Pulser/Preamplifier for Pulse-Echo Inspection

The PR-06-04 four-channel pulser/preamplifier is used for pulse-echo. Each channel can drive a conventional UT probe for a higher gain pulse and boost the return signal, improving detection and the signal-to-noise ratio. The PR-06-04 unit can also be used as a pulser or a receiver only.

Specifications

Pulser

- -45 V to -220 V input level (min-max)
- -160 V to -190 V output amplitude (pulser at 100 ns)
- 4 ns to 10 ns rise time and fall time

Receiver

- 40 dB gain
- 8 dBm to 12 dBm input level (max.)
- 8 dBm to 12 dBm output level operation
- 550 kHz to 30 MHz bandwidth at -3 dB



Ordering Information

Part Number	Item Number	Package Contents
PR-06-04	U8750028	PR-06-04 pulser/preamplifier
OPTX667	U8775012	PR-06-04 pulser/preamplifier, four 0.6 m UT probe cables (LEMO® 00 to 90° Microdot™), and a bracket to attach the unit to an HSMT-type scanner. (P/N: HSMT-A-BRKEX [U8779090]).

Note: These packages have been created to be used that has an umbilical cable with an integrated power cable. If no such umbilical is used, an optional power cable must be ordered. Due to power requirements, the PR-06-04 cannot be connected to the OmniScan power output. Please note that product availability varies by region. Contact your local Olympus sales office for more information.

Options

Transformer and Cable

Transformer (120 VAC to 240 VAC input to 12 VDC output) with a 5 m power supply cable. **P/N:** TRPP-5810-A-03 [U8800490]

Transformer (120 VAC to 240 VAC input to 12 VDC output) with a 10 m power supply cable. **P/N:** TRPP-A-PWRC-AC-10M [U8779168]

Cables and Adaptors

Umbilical Cables

Umbilical cables are used to make all the connections between the scanner and the acquisition unit. They can be of two types:

- Closed umbilical
- Divisible conduit

Closed umbilical

The closed-type umbilical offers the best rugged protection. It covers the cable with a resistant, waterproof, and dust proof conduit. It is also fitted with a safety hook on both ends and comes in different models according to the applications and scanners with that it is intended to be used with. The configuration of the cables is fixed and cannot be changed afterwards.



Ordering information for Umbilical cables

UMB-UTPA0202-10-RO

Umbilical cable type

UT and PA cables

Cable length

Power cable

Umbilical cable type

UMB1 = Umbilical for HSMT scanners.

UT and PA cable

UT = RG174 coaxial cables for conventional UT probes.

PA0000 = 128-element OmniScan® PA probe extension.

PA0202 = 124-element OmniScan PA probe extension with 4 LEMO® 00 at pin 63–64 and 127–128.

IBTx = 128-element Interbox with two OmniScan PA probe connectors, TRPP 5810™ unit, and x (0, 4, or 8) extra UT channels.

IBx = 128-element Interbox with two OmniScan PA probe connectors and x (0, 4, or 8) UT channels.

64IBTx = 64-element Interbox with two OmniScan PA probe connectors, TRPP 5810™ unit, and x (0, 4, or 8) extra UT channels.

64IBx = 64-element Interbox with two OmniScan PA probe connectors, and x (0, 4, or 8) UT channels.

Cable length in meter*

5 = 5 m

10 = 10 m

Power cable

RO = Remote pulser/receiver or Interbox power cable linking to an OmniScan® or AC-using adaptor.

*Can be customized, common values shown. Note that, under certain circumstances, the use of longer phased array cables can lead to signal degradation due to attenuation and/or crosstalk.







Divisible conduit

The divisible type is composed of two split shells that completely protect the cables. Even though it is not as rugged as the closed-type umbilical, it offers other advantages. Because the cables can be changed inside at any time, there is no need for connection boxes, which are often needed for PA probes on the scanners. The probes must have the proper cable length to reach the acquisition unit.

Ordering information

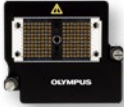
Part Number	Item Number	Description
60BA5028	U8779093	One 0.3 m divisible cable conduit with a 16 mm ID. Well-suited to 2 × PA, irrigation tube, and the encoder cable.
60BA0109	U8779094	One 0.3 m divisible cable conduit with a 19.2 mm ID. Well-suited to 2 × PA, 2 × conventional UT, irrigation tube, and the encoder cable. Standard equipment on the HydroFORM™ scanner.
60BA0131	U8775093	One 0.3 m divisible cable conduit with a 24.2 mm ID. Well-suited to 2 × PA, 4 × conventional UT, irrigation tube, encoder, and preamplifier power supply cables.
OPTX0719	U8779095	One 5 m divisible cable conduit with 24.2 mm ID. Well-suited to 2 × PA, 4 × conventional UT, irrigation tube, encoder, and preamplifier power supply cables. Standard equipment on the WeldROVER™ scanner.

Adaptors and Extension Cables

Part Number	Item Number		Description
ADAPTORS			
OMNI-A2-ADP03	U8775202		Adaptor for Hypertronics® PA probe to instrument with an OmniScan® connector. Compatible with OmniScan PA instruments.
OMNI-A-ADP05*	U8767016		Y adaptor with OmniScan connectors to support two PA probes with a maximum of 64 elements each. Compatible with OmniScan MX. instruments. Connector layout: one female output and two male inputs.
OMNI-A2-SPLIT64	U8100135		Y-adaptor (splitter) with OmniScan connectors to support 2 phased array probes. Compatible with the OmniScan MX2 with PA2 modules. Part number details SPLIT64: Compatible with 64 element PA2 modules SPLIT128: Compatible with 128 element PA2 modules 4UT: Features four LEMO® 00 UT connectors
OMNI-A2-SPLIT64-4UT	U8100136		
OMNI-A2-SPLIT128	U8100133		
OMNI-A2-SPLIT128-4UT	U8100134		
OMNI-A-ADP11*	U8767019		Adaptor with LEMO 00 connectors. Enables the use of up to 8 conventional UT probes with an OmniScan MX PA instrument.
OMNI-A-ADP12	U8767020		Adaptor with LEMO 00 connectors. Enables the use of up to 16 conventional UT probes with an OmniScan PA instrument. Supplied with a 1 m cable.

*These adaptors cannot be connected directly to the OmniScan MX2 instrument. To make the connection, a PA extension cable is needed (E128P type, shown on table below).

PHASED ARRAY EXTENSION CABLES (COMMON MODELS)

E128P0-0202-OM	U8800635		An extension cable with an OmniScan connector at both ends. Can be fitted with 4 LEMO 00 connectors enabling the simultaneous use of conventional UT and PA probes with a PA instrument. Option: A bracket for mounting the OmniScan PA extension on HSMT scanners. P/N: HSMT-A-BRKEX [U8779090]
E128P5-0004-OM	U8800441		
E128P5-0202-OM	U8800442		
E128P10-0004-OM	U8800431		
E128P10-0202-OM	U8800432		

Combining extension cables with adaptors offers numerous connection possibilities.

Ordering information for PA Extension Cables

E128P10-0202-OM

Number of elements _____ Instrument connector
 Cable type _____ Probe connector
 Cable length _____

Number of elements in extension

128 = 128 elements

Cable type

P = Flexible PVC cable
 M = Metal armor outer cover

Cable length*

0 = 0.5 m
 5 = 5 m
 10 = 10 m

Connector on the probe side*

0000 = OmniScan connector and 0 LEMO
 0004 = OmniScan connector and 4 LEMO at pins 125–128
 0202 = OmniScan connector and 4 LEMO at pins 63–64 and 127–128
 HY = Hypertronics connector

Connector on the instrument side*

OM = OmniScan connector
 HY = Hypertronics connector

* can be customized, common values shown.

Note: Under certain circumstances, the use of longer phased array cables can lead to signal degradation due to attenuation and/or crosstalk.

Interbox



The InterBox interconnection box is an ergonomic solution for a common problem associated with scanner accessories and connection buildup. This compact hub can connect two phased array probes and two amplified TOFD channels in addition to eight conventional UT channels driven by a phased array acquisition unit. The InterBox unit can integrate a PA splitter, a TRPP 5810™ TOFD pulser/preamplifier, and up to eight extra conventional UT connections, depending on the configuration.



Ordering information

EIB-T-8-M-5-OM

Extension type
TRPP 5810
UT connector

Instrument connector
Cable length
Cable type

Extension type

- IB = InterBox of 128 elements (can connect two PA probes of maximum 64 elements each)
- IB64* = InterBox of 64 elements (can connect two PA probes of maximum 32 elements each)

* Required for OmniScan® PA instruments with 64 elements.

TRPP 5810™ Unit

- T = TRPP 5810 included
- NT = TRPP 5810 not included

Conventional UT connectors (LEMO® 00)

- 0 = Zero connectors
- 4 = Four connectors
- 8 = Eight connectors

Cable type

- P = Flexible PVC cable
- M = Metal armor outer cover

Cable length in meters

Instrument connector

- OM = OmniScan® connector
- HY = Hypertronics® connector

Under certain circumstances, the use of longer phased array cables can lead to signal degradation due to attenuation and/or crosstalk.

Indexer Clicker



Clicker-scanner

5 m long cable, laser guide, and a scanner mounting bracket compatible with HSMT scanners
P/N: Q7500012

Using an indexer clicker is an economical way to create a C-scan with a one-axis scanner. The indexer clicker is offered in two different models optimized for either manual or semi-automated inspection.

Both models feature:

- Ergonomic handle
- LEMO 16-pin encoder input
- Indexing button
- Configurable digital input (DIN) button
- Encoder cable with LEMO 16-pin connector compatible with current OmniScan instruments



Clicker-manual

2.5 m cable for manual operation
P/N: Q7500011

Couplant Feed Units

CFU03 and CFU05 Electric Couplant Feed Units



CFU05

CFU03

The CFU03 and CFU05 portable electric-pump units are used to supply couplant to wedges during ultrasonic inspections. Both units are equipped with a diaphragm pump equipped with a bypass to ensure a constant flow and avoid any pump priming issues. The pump units are also equipped with a valve to control the outlet flow. The CFU05 unit features water-suction capabilities to reduce water loss when used with certain water delay line wedges.

CFU03 Features

- A diaphragm pump with a flow of 3.78 l/min (1 GPM) at 60 psi.
- An internal bypass that ensures the pump is always primed.
- Operates on 100 VAC and 240 VAC.
- Start/Stop button.
- An outlet flow control valve.
- A pump inlet tube equipped with a filter and check valve to ensure that the tube is always filled.
- Inlet and outlet quick-connect fittings.
- A rugged plastic case.
- CE certified.

CFU05 Features

The CFU05 unit has the same features as the CFU03, plus:

- Water suction generated by a Venturi system using an external compressed-air supply.

Standard Inclusions

- 3.3 m (10 ft), 9.5 mm (3/8 in.) ID tube for pump inlet with filter and check valve.
- 3.3 m (10 ft), 9.5 mm (3/8 in.) ID tube for vacuum outlet (CFU05 only).
- 3.3 m (10 ft), 5 mm (3/16 in.) ID tube and Y adaptor for pump outlet.
- 3.3 m (10 ft), 5 mm (3/16 in.) ID tube and Y adaptor for vacuum inlet (CFU05 only).
- Power supply, 100 VAC to 240 VAC input to 24 VDC output.



WTR-SPRAYER-8L

Manual Couplant Feed Units

The manual-pump unit offers an affordable and efficient way to supply couplant to wedges during automated inspections.

Features

- Reservoir capacity of 4 L or 8 L
- Flow valve
- Supplied tubes: 8 mm OD and 5 mm ID
- Sling for easy transport

Ordering Information

Part Number	Item Number	Description
CFU03	U8780008	Electric couplant feed unit
CFU05	U8780009	Electric couplant feed unit with suction capability
WTR-SPRAYER-4L	U8775153	4 L manual water pump with irrigation tubes and fittings
WTR-SPRAYER-8L	U8775001	8 L manual water pump with irrigation tubes and fittings

Yokes

Yokes are used to attach the wedges to the spring-loaded arms (SLA) used on most scanners. Depending on the wedge model used, the yoke model changes. The yokes below are compatible with HSMT scanners, the WeldROVER™ scanner, and the GLIDER™ scanner.

Ordering Information

Part Number	Item Number	Wedge compliance	Button OD (mm)	A (mm)	B (mm)
STANDARD YOKES					
ADIX689	U8775048	ST1, ST2, SPE1, SPE2, SPE3, and SA0	5	31.75	23.5
ADIX655	U8775047	SA1, SA2, SA10, SA11, SA12, SA31, SA32, SI1, SPWZ3, SNW1-AQ25 (WR), and SNW3-AQ25	8	40	55
ADIX612	U8775046	SA10, SA11, SA31, and SA32	8	40	38
OTHER YOKES					
ADIX1354	U8775187	SPWZ1 and SA14 (in reverse position)	8	40	46
ADIX1082	U8780194	SPWZ1, SA14, RexoFORM, and SNW3-AQ25-WR	8	40	65
ADIX853	U8775055	SA1-L (lateral)	8	45	60
ADIX846	U8779096	SA3	8	50	55
ADIX893	U8775084	SA4, SA5, and HydroFORM-A-LiteHolder	8	55	55
ADIX908	U8779097	Water wedge	8	50	65
ADIX1325	U8775132	SNW1	8	31.75	55
ADIX1482	U8775165	SNW2	8	31.75	23.5
ADIX1481	U8775164	SNW3	8	31.75	65
ADIX1896	Q7750014	SA17-DN	5	50	38
ADIX1897	Q7750015	SA17-N	5	31.75	38
ADIX870	U8775056	SA27-DN and creeping wave probe holder (ADIX1129) [U8775080]	5	40	23
Y-PA-65x64-5Deg	Q7750157	SI5	8	64	65

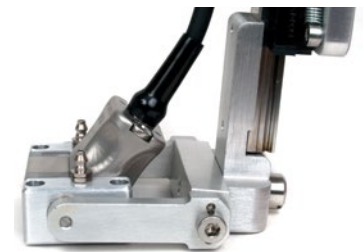
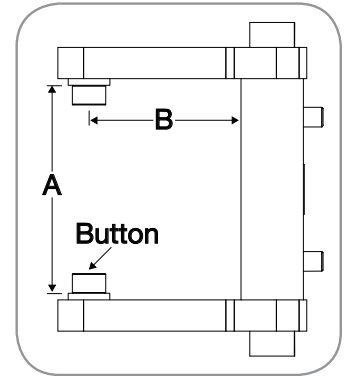

Aqualene Elastomer Couplant

Aqualene™ is an elastomer designed for ultrasonic inspection applications. Acoustic impedance of the material is nearly the same as water, and its attenuation coefficient is lower than many documented elastomers and plastics.

Applications for nondestructive testing include:

- Flexible couplant pads with minimal water addition.
- Low-velocity delay lines.
- Water-box membrane.

Aqualene elastomer couplant reduces the drawbacks of wet coupling when used on porous or refractory surfaces. It allows a minimal amount of couplant to be used while protecting the probe when in direct contact with the part. Furthermore, Aqualene can serve as a thermic insulator. Aqualene couplant products are available in many sizes and thicknesses.

Ordering Information

Part Number	Item Number	Description	Size (L x W x H) mm (in.)
29HD0002	U8770300	Plate	146 × 146 × 2 (5.75 × 5.75 × 0.08)
29HD0004	U8770301	Plate	152 × 152 × 6.4 (6 × 6 × 0.25)
29HD0005	U8770302	Plate	102 × 102 × 25.4 (4 × 4 × 1)
29HD0009	U8770299	Plate	102 × 203 × 2.3 (4 × 8 × 0.09)
29HD0010	U8770303	Plate	200 × 100 × 0.5 (7.9 × 3.9 × 0.02)
29HD0011	U8770304	Plate	127 × 127 × 25.4 (5 × 5 × 1)



How to Order

For pricing or additional information, contact your local sales representative.

To quickly locate your local sales representative, go to www.olympus-ims.com.

Training

Olympus works with major training companies to develop our Training Academy to offer comprehensive courses in phased array technology and applications. Courses range from a two-day "Introduction to Phased Array" program to an in-depth, two-week "Level II Phased Array" course. In both cases, students experience practical training utilizing the portable OmniScan® phased array flaw detector. Courses lead to either recognized certification or certificates of attendance.

Courses are currently being offered at the training facilities of participating companies and at customer-determined locations worldwide. Customized courses can also be arranged. Check the latest course schedule in the "Support" section at www.olympus-ims.com.

www.olympus-ims.com

OLYMPUS[®]

For inquiries - contact
www.olympus-ims.com/contact-us

OLYMPUS CORPORATION OF THE AMERICAS

48 Woerd Avenue, Waltham, MA 02453, USA, Tel.: (1) 781-419-3900
110 Magellan Circle, Webster TX, 77598, USA, Tel.: (1) 281-922-9300

OLYMPUS NDT CANADA INC.

3415, rue Pierre-Ardouin, Québec (Québec) G1P 0B3, Tel.: (1) 418-872-1155
1109 78 Ave, Edmonton (Alberta) T6P 1L8

OLYMPUS SCIENTIFIC SOLUTIONS AMERICAS CORP.
is certified to ISO 9001, ISO 14001, and OHSAS 18001.

*All specifications are subject to change without notice.

All brands are trademarks or registered trademarks of their respective owners and third party entities.

Olympus, RollerFORM, HydroFORM, COBRA, and OmniScan are registered trademarks, and HSMT-Compact, HSMT-Flex, SteerROVER, Mini-Wheel, VersaMOUSE, RexoFORM, WeldROVER, ChainSCANNER, GLIDER, MapSCANNER, MapROVER, Dual Linear Array, and TRPP 5810 are trademarks of Olympus Corporation.

LEMO is a registered trademark of LEMO SA. Microdot is a trademark of Tyco Electronics Corporation. Rexolite is a registered trademark of C-Lec Plastics Inc. Hypertronics is a registered trademark of Hypertronics Corporation. Copyright © 2018 by Olympus.



EO440031EN

